

VIGAS

Gasifying boilers

MANUAL FOR INSTALLATION, ASSEMBLY,
MAINTENANCE AND USE

Warranty Certificate

**VIGAS 12 DPA, 18 DPA, VIGAS 26 DPA
with AK4000 control**



Content	Page
Declaration of conformity.....	3
1. Technical description.....	4
2. Technical data.....	5
3. AK4000 control description.....	7
4. Boiler VIGAS DPA fuel PELLETS	9
5. Boiler VIGAS DPA fuel WOOD.....	12
6. Water outlet temperature setting.....	17
7. Time setting.....	18
8. Hardware and software information.....	18
9. Error notification.....	18
10. Configuration set up using PIN 0000.....	19
11. Operating instruction.....	24
12. Boiler maintenance and repairs.....	27
13. Boiler accessories and assembly.....	29
14. List of service centers.....	30
15. Problems, causes and solutions.....	31
16. Installation instructions.....	33
17. Wiring diagram.....	35
Warranty Certificate.....	37
Commissioning Certificate VIGAS DPA	37

EC DECLARATION OF CONFORMITY

Issued according to § 12 sec. 3 let. a) Act No. 264/1999 Statute
and 97 / 23 EC

WE, Pavel Vigaš - VIMAR,

M. Čulena 25
974 11 Banská Bystrica
SLOVAKIA
VAT no.: SK 1020548001

hereby declare on our full responsibility, that referred products comply with technical requirements, products are safe if terms of use are followed. We secured all actions, which continuously establish compliance, provide conformity of referred products with technical documentation within specifications and legal requirements. If any changes occur on the device without permission of producer, this statement loses its validity.

Product: Warm water boiler VIGAS DPA with AK 4000 control

Type: VIGAS 12 DPA, VIGAS 18 DPA, VIGAS 26 DPA

Producer: Pavel Vigaš - VIMAR
M. Čulena 25, 974 11 Banská Bystrica,
SLOVAKIA

Competent statutory codes (CSC)

CSC no. 576/2002 Statute – Pressure equipment Directive (97/23/EC)
CSC no. 308/2004 Statute – Low voltage electric devices (2006/95/ES)
CSC no. 194/2005 Statute – Electromagnetic Compatibility Directive EMC (2004/108/EC)

Used harmonized standards for CE marking

EN 303-5: 2012; EN 60335-1: 2012; EN 60335-2-102/A1 : 2010
EN 61000-6-3/A1/AC; EN 55014-1/A2 : 2012; EN 61000-3-2/A2: 2010
EN 61000-3-3: 2014; EN 61000-6-2

Additional date: Certificates

Certificate 0063/104/2017 VIGAS 12DPA
Certificate 0023/104/2015 VIGAS 18 DPA
Certificate 0063/104/2016 VIGAS 26 DPA

CE was proceeded according to § 13, sec. 3a) Act no. 264/1999 Statute per amendments.

Issued in: Banská Bystrica

Statutory name: VIGAŠ Pavel

Date of issue: 14.12.2017

Title: owner

Signature:



1. TECHNICAL DESCRIPTION

Combined warm water boiler **VIGAS DPA** offers two different systems of fuel combustion. Wood fuel combustion provides effective way applied with all Vigas boilers. Pellet fuel heating is provided by classic burning process on fire grate, made of heat resistant steel, where pellets are delivered by screw feeder. Boiler **VIGAS 18 DPA** and **VIGAS 26 DPA** is designed to burn pellets with diameter of 6 mm and length up to 40mm, as well as dry wood materials from sawdust to wood logs of 52 (**VIGAS 12 DPA** 37 cm) cm long, with max. diameter 20 cm. Sawdust, woodchips and cuttings are recommended to burn together with wood logs.

Boilers are welded from 4 and 6 mm steel sheets. Inner boiler sheets, which are in contact with boiler gases are 6 mm thick, others are made of 4 mm steel. The heat exchanger is welded from 57 x 4,5 mm steel pipes. External casing of is made of 0,8 mm steel sheets. Heat insulation of the boiler is formed by 20-50 mm mineral wool. The combustion gas is discharged through steel flue gas into the chimney. The pellet container is designed from 1,5 mm steel sheet and its volume is 225L for 12DPA, 250 L for 18DPA, 340 L for 26DPA. The integral components of the boiler include: front gear unit, electric ignition unit, security tourniquet, air distributor with servo and fan, chimney temperature sensor, ultrasound sensor to detect level of pellets. Internal space consists of combustion chamber, where fuel is dried and combusted. Produced wood gas is carried through nozzle into combustion chamber, where it burns with support of secondary air.

Pellets are led directly to combustion chamber by accurate dosing from container during combustion with assistance or regulated air supply. Furthermore, the flue gases are led to double-row heat exchanger, where intensively cooling down until reaching the flue gas. Unburned ashes and waste is seated in the combustion chamber, which is advised to be clean approximately once a week. Boiler offers simple maintenance due to AK4000 control, located on the top of the boiler.

Control AK4000 offers and permits following actions:

- to control heating temperature reached by changing of fan speed using by PID regulator
- to control and manage operation of pellet feeding device
- to read water boiler temperature
- to read volume of pellets in the container
- to read temperature of flue gases
- to read motor temperature of pellet feeding device
- to connect and control the discharge fan
- to connect and control circulation pump
- to connect and control room thermostat
- to connect extended regulation (Expander AK 4000) via BH BUS
- to connect modul AK 4000M for data back-up and possible evaluation via PC
- option for graphic view of hydraulic schemas with connection per requirements

SAFETY FEATURES

Boiler is supplied with STB safety, which disconnects the boiler fan to avoid boiler overheating above 100 °C and it is equipped with safety cooling exchanger according to EN 303/5: 2012. Manufacturer recommends to purchase Honeywell TS131 3/4" safety valve - to be assembled to the safety cooling exchanger. The boiler is equipped with a safety cell feeder (tourniquett) driven by chain transmission to avoid pellet re-ignition inside container. In case of power failure or device error, there is always security air gap between the container and pellet combustion chamber which prevents ignition of the pellets in the container. To avoid engine gear damage by possible feeding screw blockage or tourniquet blockage, the boiler is equipped with a safety thermometer that detects the temperature of the engine and if temperature is 80 °C, engine will shut down.

2. TECHNICAL DAT		Chart 1		
Warm water boiler				
Combined boiler Wood and Pellets		VIGAS 12 DPA	VIGAS 18 DPA	26 DPA
Energy efficiency class		A++	A++	A++
Nominal boiler output WOOD/PELLETS	kW	16 / 12	24 / 18	36 / 26
Boiler class acc. EN 303-5:2012		5		
Max. operating pressure	bar	3		
Fuel WOOD		Max. wood moisture 20% of heating value. 15 MJ/kg		
Fuel PELLETS		Pellets diameter 6 mm, length 40 mm (16,5 – 19 MJ/kg) Standard: ÖNORM M 7135, DIN 51731, EN plus A1		
Power range WOOD	kW	7 – 17	8 - 24	15 - 38
Power range PELLETS	kW	1,8 – 12,9	1,8 - 18	
Fuel consumption with nominal output WOOD/PELLETS	kg/hrs	4,2 / 2,8	6,3 / 4,5	9,5 / 5,5
Chimney draught	mBar	0,15 - 0,20		0,15 – 0,25
Minimum height /chimney diameter	m/mm	8 / Ø160		8 / Ø200
Temperature setting option	°C	70 - 85		
Weight	kg	450	480	520
Water volume	l	60	75	105
Average gases temperature				
Nominal power (Wood)/(Pellets)	°C	165/155	210/160	260/165
Minimum power (Wood)/(Pellets)	°C	105/75	105/90	105/100
Wood chamber capacity	l	80	105	160
Door dimension (w-h)	mm	435 -255		
Wood chamber dimension				
Depth	mm	370	520	
Height	mm	500		740
Width	mm	380		
Max. weight of wood fuel	kg	20	35	50
Pellet container capacity	l	225	250	340
Max. weight of pellet fuel	kg	135	165	225
Noise level	dB	45,5		
Max. el. power during ignition	W	1600		
Max. el. input during burning (Wood)/(Pellets)	W	13,8 / 84,9	29,9 / 84,9	37,6 / 130,5
Voltage/ frequency	V/Hz	230ACV/50		
Pressure water loss :				
Δt 10 °C	mBar	4,26	9,97	10,48
Δt 20 °C	mBar	1,06	1,15	2,55
Burning time at nominal power				
Wood	hours	4,5	6,0	4,2
Pellets	hours	48	35	40
Cooling heat exchanger				
- water temperature inlet	°C	4 – 15		
- water pressure inlet	bar	min. 1 – max. 4		
SAFETY		Drain valve HONEYWELL TS 131 ¾" Release temperature 95 °C STB fuse, release temperature 100 °C (tolerance: -6 °C – 0°C)		
Flue gas mass flow		0,034 – 0,047		

2.1 DIMENSION CHART AND THE POSITION OF SAFETY PLATE TO ENSURE PROTECTION OF INFLAMMABLE FLOORING

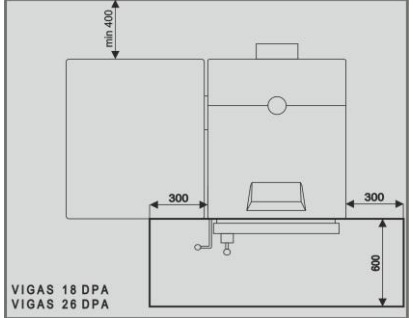
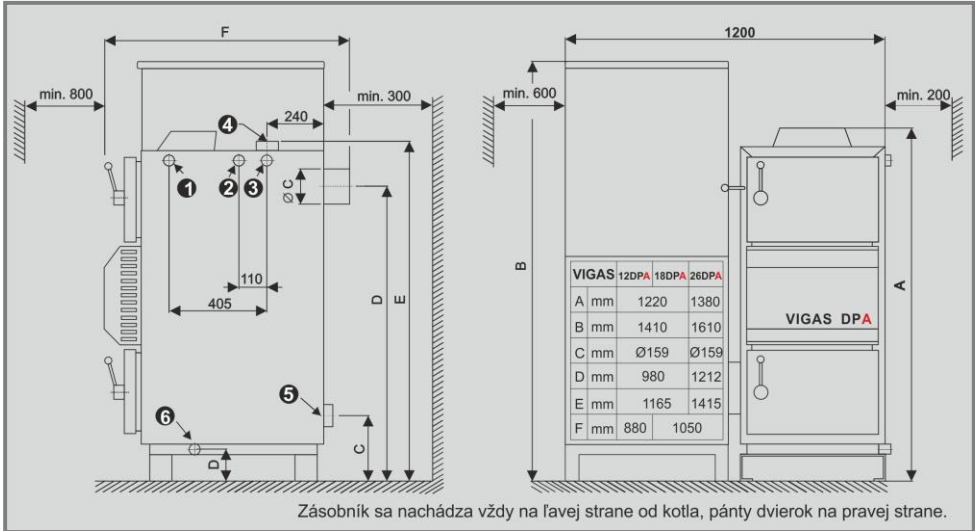

- ① Input insert for valve TS131 3/4"
- ② Opening for immersion pocket 1/2"
- ③ Outlet for cooling water 3/4"
- ④ Water outlet 2"
- ⑤ Water inlet 2"
- ⑥ Water filling valve 1/2"

2.2 BOILER SCHEMATICS

Schema VIGAS DPA

Pic.3

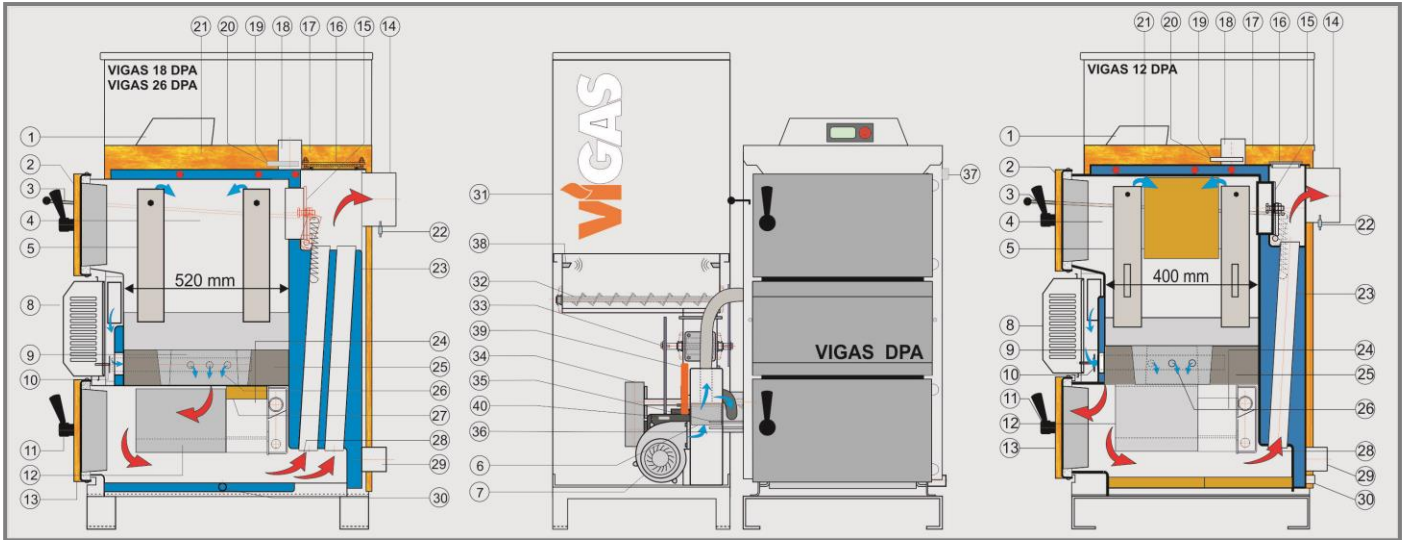

DESCRIPTION	
1. Control AK 4000	14. Chimney flue
2. Upper door	15. Firing shutter
3. Chimney flap opening rod	16. Heat exchanger cover
4. Wood chamber	17. Upper back cover panel
5. Primary air supply	18. Water outlet
6. Shutter	19. Fuse STB
7. Fan	20. Temperature sensor
8. Cover panel	21. Upper front cover panel
9. Nozzle	22. Gas temperature sensor
10. Secondary air shutter	23. Heat exchanger pipes
11. Handle	24. Pellet burner
12. Fire clay bricks	25. Fire proof lining
13. Bottom door	26. Secondary air
	27. Combustion chamber
	28. Flue gas direction
	29. Return water mounting
	30. Water inlet
	31. Pellet container
	32. Pellet screw feeder
	33. Chamber feeder (tourniquet)
	34. Driving gear
	35. Ignition coil
	36. Connection device
	37. Safety cooling exchanger
	38. Ultrasound pellet sensor
	39. Servo-drive
	40. Safety temperature sensor

3. DESCRIPTION OF AK 4000 CONTROL

3.1 Safety instructions

- Before you plug-in the power cord, please check all protective cover panels.
- Avoid any contact of power cord with hot parts of the boiler (e.g. gas flue)
- Make sure that upper insulation under the cover panel remains dry (risk of short circuit if damp)
- Do not use any violent tow on the power cord.
- Always disconnect the power cord, when new electrical devices are being installed to the boiler (e.g. room thermostat, discharge fan, circulation pump).
- Do not remove protective cover panels, in particular the fan cover, when boiler in servise.
- Check, whether voltage on the label is the same as your distribution network.
- Always follow safety operation manual.

3.2 Connection to power supply

Control AK 4000 presents integral part of VIGAS boilers. The control will be connected when power cord is plugged into a 220/230V power supply. The display is active when power cord is plugged-in (Pic.4).

Pic.4

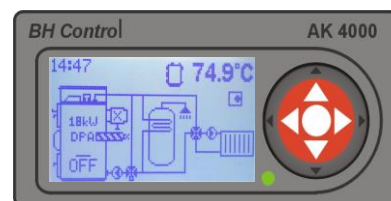

3.3 Operating conditions

Control AK 4000 is designed for operation with area temperature between +5 and +45 °C. The control cannot be used in moist environment or in direct sunlight.

3.4 Maintenance of AK 4000 control

Keep in clean and dust free environment. Anti-static cloth or wet wipes are recommended to remove dust or impurities from metal cover or control panel.

3.5 Control panel

Electronic control panel is equipped with buttons, display including symbols. Further information is available in the following chapters of the manual. The button options have combined functions, it depends on provided text and individual boiler configuration setting.

Pic.6

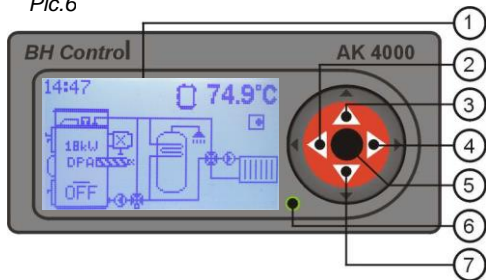

1. Graphic display 128 x 64 pixels
2. Button ◀ with functions, ENTER
3. Button ▲ with functions,
4. Button ▶ with functions, EXIT menu (ESC) ,
5. Button ● (ENTER) with functions,
6. LED light (green OK, red ERROR),
7. Button ▼ with functions.

Graphic information

Pic.7

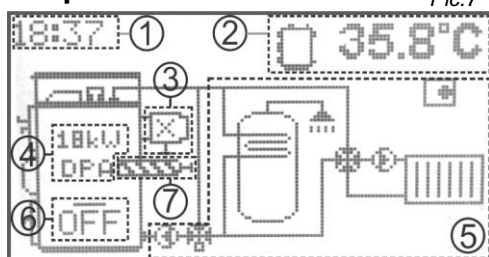





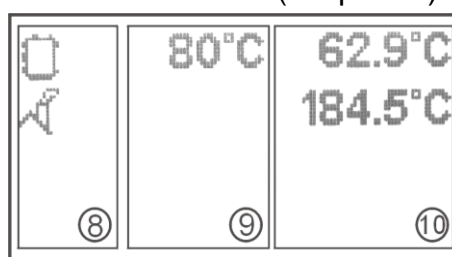









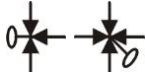











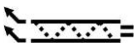

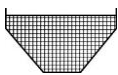







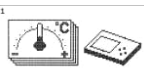
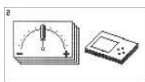
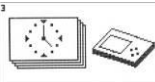
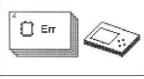

1. Real time image.
2. Information line - current boiler figures shown Change ▲ or ▼.
3. Information about discharge fan and gas sensor .
4. Information about nominal power, when boiler is off.

Line information (chap.10.5)

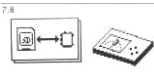

5. Graphic information about hydraulic schema
6. Boiler status information.
7. Pellet feeder information.
8. Symbols
9. Set figures
10. Current figures

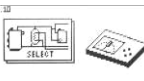
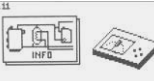
3.6 LIST OF SYMBOLS

Boiler		Accumulator tank		External boiler	
Boiler switched on	ON	DUOMIX		Heating circuit	
Boiler switched off	OFF	Valve with servodrive		Room thermostat	
Start fire	 ON	Pump		3-way thermo valve	
Burning	 73 °C	Discharge fan		LADOMAT	
Burn out	 52 °C	Lambda sonda	λ	Floor heating	
End of burning	END	Thermometer	T	Fan perform. modification	
Boiler power PELLETS	 60%	External thermometer		Boiler power WOOD	 45%
Ignition mode		Screw feeder		Pellet volume indicator	
Room thermostat decay		Indication figure error	X	Temperature of feeder device	
Ultrasound pellet sensor		Fuel change Wood → Pellets		Boiler power change	
Fuel WOOD		Minimum gas value	 end	Maximum gas value	 max
Fuel PELLETS		Servo position fuel WOOD		Servo position fuel PELLET	
Temperature setting		Parameters setting		Time setting	
Error notifications		Programm		Configuration data	
Service settings		Memory modul		Motion control	
Schema options		Installation data		View option	

4. Boiler VIGAS DPA fuel PELLETS

Boiler VIGAS 18 DPA offers possibility, that during fuel change from pellets to wood or wood to pellets, it is not necessary to perform any technical modifications on the boiler body. It is only required to choose type of fuel on the display of AK 4000 control. After selecting the fuel type, servomotor driven shutter will automatically move to desired position (pic.3/6). Boiler design and air control enables automatic transition of fuel from „WOOD“ to „PELLETS“, after „WOOD“ fuel has burned out.

Quick choice selection of fuel type using round button

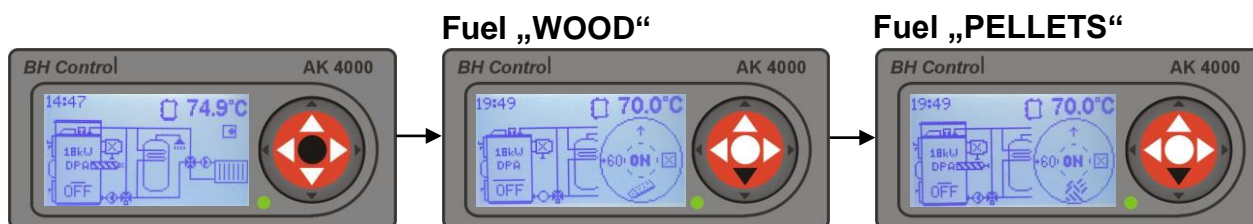

4.1 VIGAS boiler control using fuel - PELLETS

4.1.1 Switch on the boiler

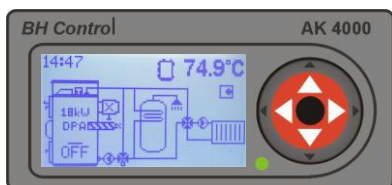

Symbol „OFF“ will appear, as shown on the picture, if boiler is switched off, by pressing middle button „ENTER“, round button pictogram appears.

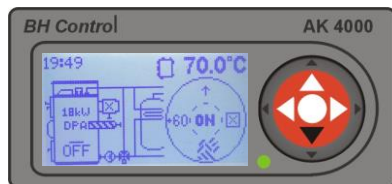

Using button ▼ select fuel pellets „“ or fuel wood „“. In case, discharge fan is used, see (chap.10.1.3) shown as this button +60 will switch on discharge fan for 60 seconds. It is used, for example during boiler clean up, it will minimize dust infiltration in the boiler room area.

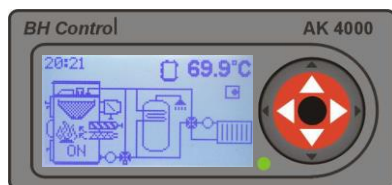

By pressing middle button „ENTER“ boiler gets into automatic pellet ignition.

4.1.2 Boiler switched on – pellet ignition mode

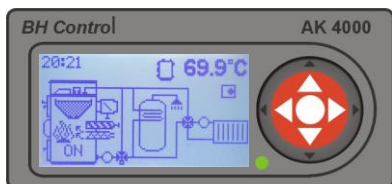

Ignition mode shows symbol „ON“. It is automatic process supported by chimney temperature monitoring.

Discription of ignition:

1. Pump on, monitoring of current chimney gas temperature.
2. Ignition coil on , fan will blow onto grate.
3. Screw feeder on .
4. Finishing ignition mode and switch to burning mode will start, when current gas temperature exceeds sensed gas temperature over 2,5 °C. The boiler will switch off, if this condition is not realized, indicated by symbol „END“ and pellets ignition error.

Igniton pellets error:

- Clean the burner (pic.3/24) too much ash on the burner,
- Check pellet volume in the container,
- Check igniton coil function (pic.3/35).

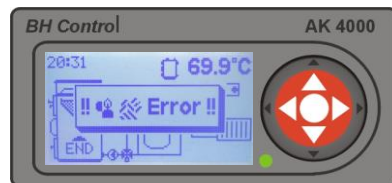

4.1.3 Boiler switched on – burning mode





Mode of combustion, the boiler will get after successful ignition of the pellets. Status is displayed by changing the "ON" → "52°C". The burning mode, the boiler is controlled by a "PID controller based on the temperature of the boiler and flue temperatures. If the boiler temperature exceeds the desired temperature by 1°C, output is 0% if the temperature drops below 3°C desired temperature, the boiler is re-ignited. Current output is displayed in percentage as a symbol. ≡ "20%".

4.1.4 Boiler shutdown (automatic)



Inside boiler container is placed ultrasound sensor, which detects pellet level. If pellets are above sensor level (container is full), this condition is displayed by symbol „“.



If pellets are below sensor level (container is half-empty), this condition is displayed by symbol „“. Simultaneously, information line shows remaining time period for boiler to shutdown. This condition is displayed by empty container symbol „“ and sign „END“.

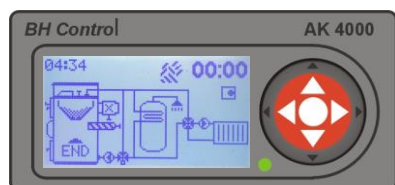

4.1.5 Boiler shutdown (manually)

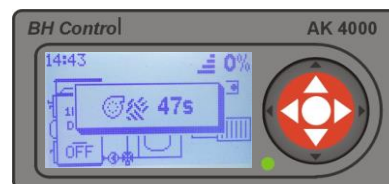
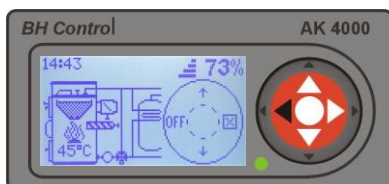
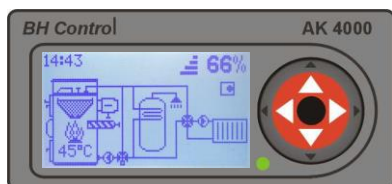

Pressing „ENTER“ display offers round button. Pressing button ◀ boiler will shut down. After shutdown, the blowing fan is switched on. During 60s period pellet burner is being cooled down. By pressing ☒ round button will disappear.

4.2 Parametres setting for fuel - PELLETS

To change setting press „ENTER“ for 2 seconds, in any boiler mode, by pressing button ▲. Parametres setting depends on type of the boiler and its configuration.

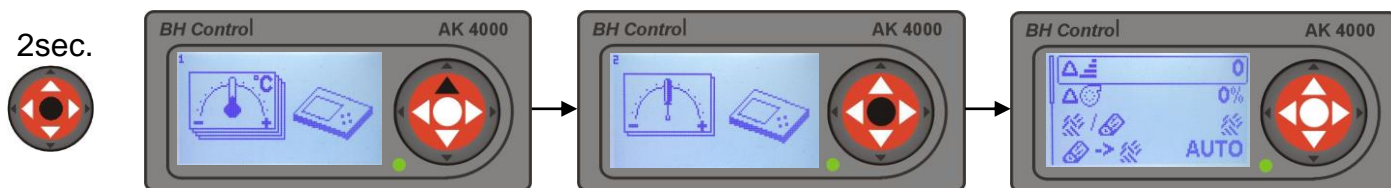

By pressing buttons ▲▼ choose parameter to be changed and pressing „ENTER“ figure starts flashing. Using ▲▼ buttons select required figure and repeatedly press „ENTER“.

4.2.1 Boiler power adjustment



Correction of output $\Delta \equiv$ can be used to increase or decrease the time of dosing pellets in the same period. The value can be set in the range of -15 to +5. One step correction = change of time of dosing in one period of 0.5 seconds. Correction can be used to achieve optimum combustion of pellets, or modification of the boiler output. When the quality of the pellets is according to EN Plus A1, it is recommended to set the correction to "0". This setting will take effect for displaying the maximum output of the boiler.

4.2.2 Fan adjustment



Fan adjustment is possible $\Delta \curvearrowright$ in case you need to increase or decrease amount of air. This figure is possible to adjust from -5% to +25%. Figure adjustment to „0“ meets pellet quality EN Plus A1. Using fan adjustment:
 Low chimney draft.....+
 High chimney draft..... -
 Lower quality pellets.....+

4.2.3 Fuel Type setting: PELLETS - WOOD



Boiler VIGAS DPA is a semi-automatic boiler for burning pellets and lump wood. When using fuel "pellets" should be selected graphic symbol . For fast access to fuel type can be used the round dial on boiler. See chapter 4.

4.2.4 Adjustment of automatic fuel transfer from "wood" to fuel "pellets"



When you select "AUTO" will occur after burning out of fuel "wood" and flue gas temperature reaches \curvearrowright end (see Sec. 5.3.2) to automatically transition to fuel "pellets" and the subsequent continuation of burning. In "Auto" mode is recommended temperature shut- \curvearrowright end 50°C. When connecting the ACCU tank, the minimum temperature shutdown automatically moves to the required temperature of the boiler. If elected, "OFF" will occur after the end temperature for the boiler and the statement "END".

4.2.5 Minimum temperature in the accumulation tank set-up



Setting the minimum temperature in the ACCU tank. The display is active only if the selected hydraulic diagram of the ACCU tank (see 10.4). Setting range 25-70°C. If the boiler exceeds the desired temperature by 1°C. there is a transition to the state of the boiler setback . The re-start of boiler is heating up and when the temperature drops in ACCU tank set value for example. 40°C (for fuel "wood").

4.2.6 Adjustment of discharge fan speed



In case of installation and selection of discharge fan (see chap.10.1.3), there is possibility using it to increase chimney effectivity by permanent running. Possibility to adjust speed from 30% up to 100% or completely shutdown to „OFF“.

4.2.7 Display brightness adjustment



Select figure for display brightness. This figure is possible to adjust from 0 to 100.

4.2.8 Display contrast adjustment

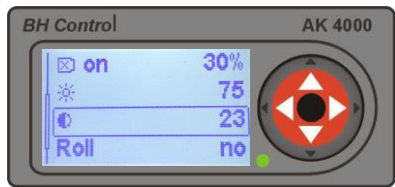

Select contrast figure of the display. This figure is possible to adjust from 16 to 24.

4.2.9 Adjustment of scrolling information line



Roll
By pressing „yes“ information line offers current boiler figures shown on display (pic.7), e.g. boiler power, boiler temperature, gas temperature, etc. By pressing „no“ choose figures for information line ▲▼.

5. BOILER VIGAS DPA fuel WOOD

Quick choice selection of fuel type using round button

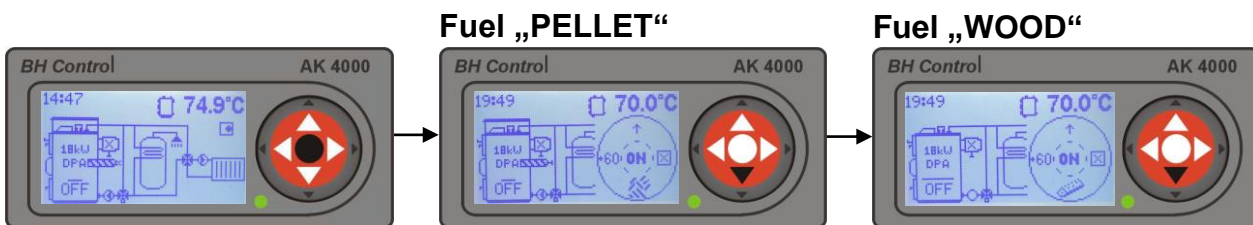

5.1 Boiler control VIGAS without discharge fan

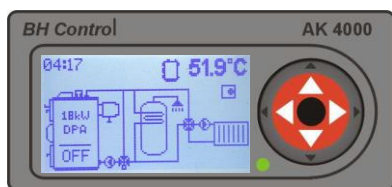

Discharge fan is an additional device for VIGAS boiler. It prevents smoke leakage into the area of boiler room, while filling up the boiler with fuel. See chap.13.3.

5.1.1 Boiler switch on

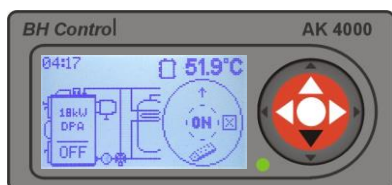

When boiler is in the „OFF“ mode, by pressing middle button „ENTER“ round button symbol will appear.



By pressing ▼ select fuel pellet „“ or fuel wood „“. When burning wood, please select option „WOOD“

Caution:

Before pressing „ENTER“ it is necessary to start fire inside boiler, following chap.11.4.

5.1.2 Boiler switched on – heating-up mode

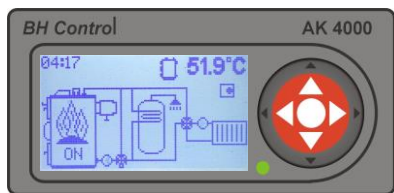

In the heating phase, the boiler gas exhaust temperature is lower than the minimum set-up exhaust gas temperature. Minimum and maximum temperatures can be modified in boiler set-up parameters. Minimum standard exhaust gas set-up temperature is up to 90°C and maximum set-up temperature is 220°C. Boiler can be in heating mode for up to 60 minutes with a minimum of 2 minutes. If the boiler does not reach the burning phase in this time, it will automatically shut down – sign „END“.

5.1.3 Boiler active – burning phase „60,1°C“

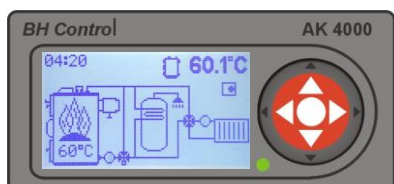

The burning phase is active when the exhaust gas temperature is (⌋ end) +10 °C or after reaching the desired temperature. The burning phase is controlled by a PID regulator on the basis of chimney and boiler temperature. If the temperature rises 1°C above the desired temperature, the output will be 0%. If it decreases >2°C below the desired temperature, the output will start again.

5.1.4 Adding fuel, boiler shutdown (manually)

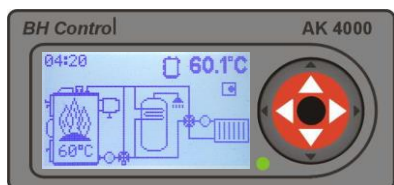

Use the graphic control. The driver will appear after pressing the middle button ENTER. The graphic driver offers options to shut down the boiler, option to add fuel or to cancel the driver.

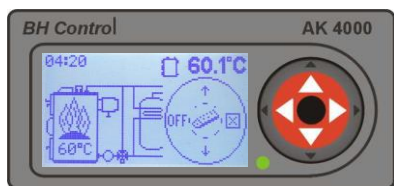

Choose one option	
OFF	Boiler shutdown
	Adding fuel
<input checked="" type="checkbox"/>	Cancellation of graphic driver
	Change displayed figure

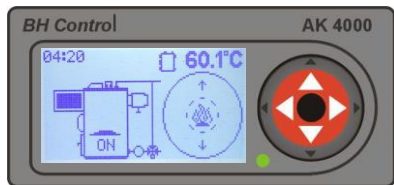
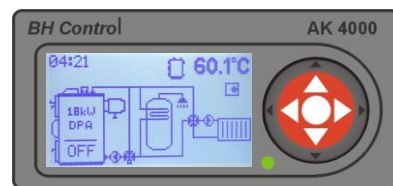

By pressing blowing fan will shut down. By pushing rod open the chimney flap and then open the upper door. Add the required amount of fuel. After fuel is added close the upper door and close the flap by pulling the rod (chap. 11.4). Press to finish adding fuel. The blowing fan will start automatically.

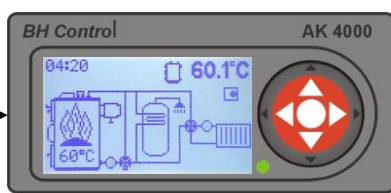
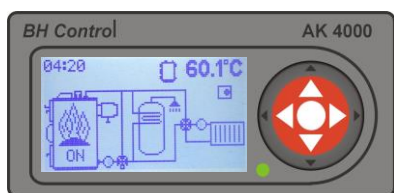

5.1.5 Boiler shutdown (automatic), switch to mode „PELLET“

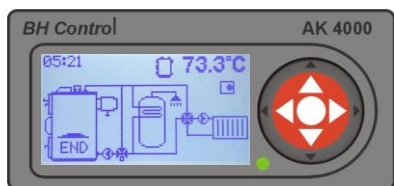

When the exhaust gas temperature drops down below the desired temperature (⌋ end) the boiler will shut down with the symbol „END“ on the display. If you selected automatic switch from „WOOD“ fuel to „PELLETS“ → , the boiler will be switched on – pellet ignition mode and the boiler continues running to the desired temperature.

Advice:

If selecting automatic switch → it is beneficial to set (⌋ end) below 60 °C, this will burn out „WOOD“ fuel completely.

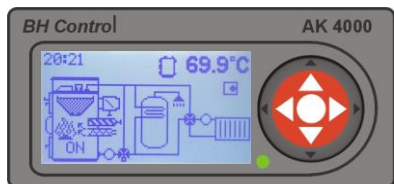

5.2 VIGAS BOILER CONTROL with discharge fan

Fuel - WOOD

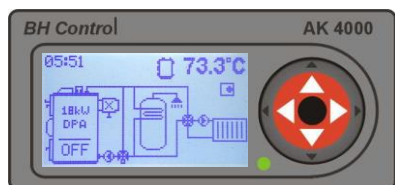

Discharge fan is optional accessory for VIGAS boiler. Discharge fan assembly provides increased comfort during heating-up and refilling mode. It helps to reduce smoke from boiler room area. When lighting up the boiler it will help to create fire base quickly. See chap. 13.3.

5.2.1 Boiler switch on

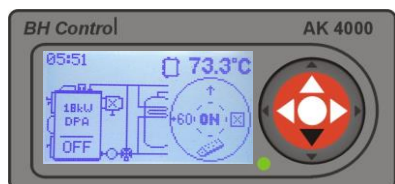

When boiler in „OFF“ mode (see display), by short pressing of middle button „ENTER“ graphic driver can be recalled.





By pressing ▼ choose fuel pellets „“ or fuel wood „“.

Warning:

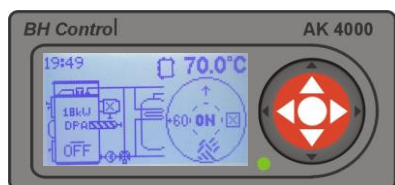

Before pressing „ENTER“ it is necessary to heat-up the boiler, follow chapter 11.4.

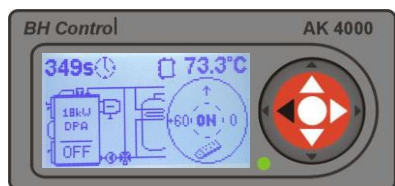

Choose one option	
+60	To start discharge fan for 60 s (used during heating-up)
ON	Switch on
<input checked="" type="checkbox"/>	Cancel display driver
	Fuel „PELLETS“ Confirm to switch to pellets „  “.
▲ ▼	Change of indicated figure



Select „+60“ new graphic driver will appear. Running time of discharge fan can be viewed in the upper corner.

+60	You can add extra 60s , maximum 360s
ON	Switch on
0	Discharge fan switched off
	Fuel „WOOD“, Confirm to switch to wood „  “.
▲ ▼	Change of indicated figure

5.2.2 Boiler active – heating phase „ON“

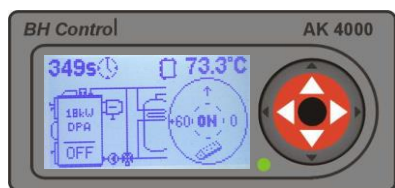

In the heating phase, the boiler gas exhaust temperature is lower than the minimum set-up exhaust gas temperature. Minimum and maximum temperatures can be modified in boiler set-up parameters. Minimum standard exhaust gas set-up temperature is up to 90°C and maximum set-up temperature is 220°C. Boiler can be in heating mode for up to 60 minutes with a minimum of 2min. If the boiler does not reach the burning phase in this time, it will automatically shut down – sign „END“.

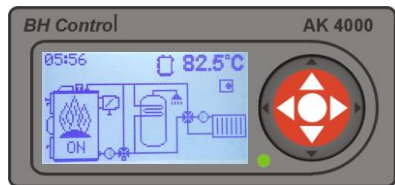

5.2.3 Boiler active – burning phase „82,5°C“

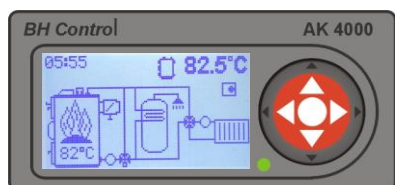

The burning phase is active, when the exhaust gas temperature is ( end) +10 °C or after reaching the desired temp. The burning phase is controlled by a PID regulator on the basis of chimney and boiler temp. If the temperature rises 1°C above the desired temp., the output will be 0%. If it decreases >2°C below the desired temp., the output will start again.

5.2.4 Fuel refill, boiler shutdown (manual),

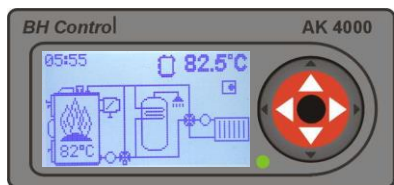

Use graphic driver. To recall display driver press middle ENTER button. The graphic driver offers options: switch off the boiler, refill the boiler or cancel driver.

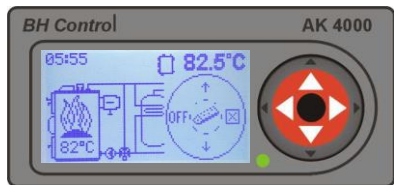

Choose one option	
OFF	Switch off
	Fuel refill
<input checked="" type="checkbox"/>	Cancel display driver
	Change indicated figure

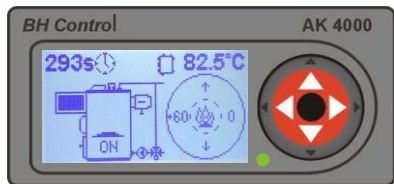
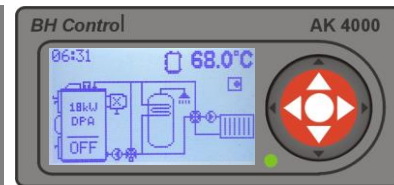

By pressing boiler switches off and discharge fan will start running for 300 s. The time is indicated in the upper left corner. By pressing „+60“ running time of the discharge fan can be exceeded. Using rod open the chimney flap, than open upper door. Add required amount of fuel. When finished, close upper door and chimney flap. By pressing „0“ discharge fan will be switched off. By pressing refill will be done, discharge fan will switch off automatically and blower fan starts.

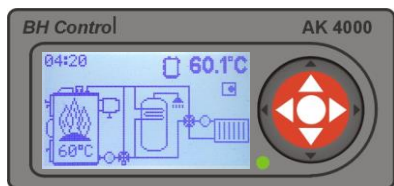
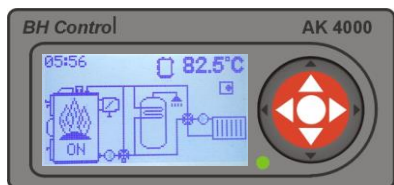

5.2.5 Boiler shutdown (automatic)

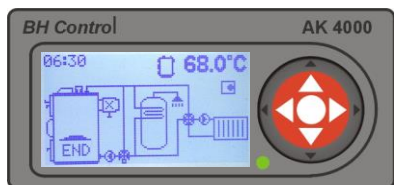

When exhaust gas temperature drops down under set temperature (end) the boiler will automatically shutdown. Sign „END“ will appear on the display. If you had selected automatic transfer from „WOOD“ to „PELLETS“ → , boiler will start – with pellet ignition mode and boiler continues heating.

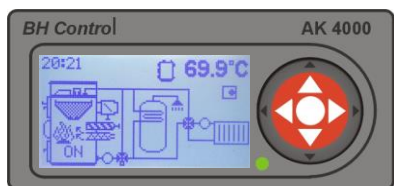

Notification:

If selecting automatic transfer → it is advised to choose (end) below 60 °C, for fuel „WOOD“ to burn out completely.

5.3 PARAMETERS SETTING

Fuel - WOOD

To get to parametres setting mode press „ENTER“ for 2 seconds, and press ▲ button. Parameter setting depends on the boiler type and its configuration.

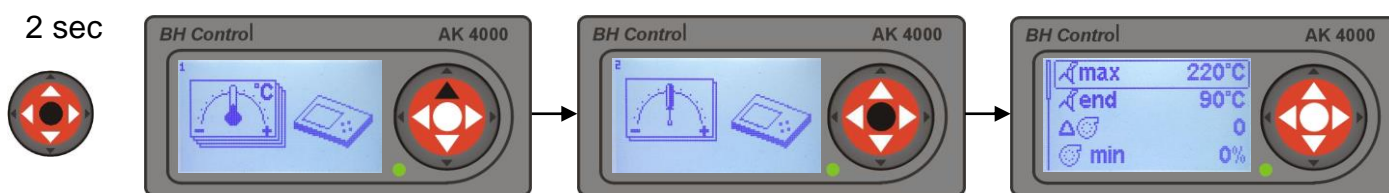

By pressing ▲▼ select parameter, you need to change and press „ENTER“, figure starts flashing. By pressing ▲▼ select required figure and press „ENTER“.

5.3.1 Maximum chimney temperature setting

			<p>By choosing maximum exhaust gas temperature, fan speed will be reduced. Temperature setting is available between 130 °C to 320 °C. Temperature setting depends on wood quality and chimney draft. Recommended value is 220 °C.</p>
--	--	--	---

5.3.2 Boiler shutdown temperature setting (shutdown temperature)

			<p>Select exhaust gas temperature, boiler and pump will shutdown automatically. Temperature setting is available between 20°C and 130 °C. By selected temperature is possible to influence size of fire base for next heat up mode. Low figure will activate complete burn out of fuel or high temperature will produce too much ash in the chamber. If you are using automatic transfer mode „WOOD“ to „PELLETS“ → , boiler will start – with pellet ignition mode and boiler will continue heating. Recommended value is below 60 °C.</p>
--	--	--	--

5.3.3 Fan power setting

			<p>By increasing or reducing this figure., boiler power can be changed. Value is possible to select between -3 and +3. One degree means approx. 10% of boiler power. Figure „0“ corresponds to boiler rated power. During mid-season period is advised to decrease this value.</p>
--	--	--	--

5.3.4 Minimum fan power setting

			<p>By increasing this value fan minimum speed can be changed fan. Value can be set between 0 % and 70 %. This option is to be used if permanent maximum boiler power needed with minimum range. For example, installation with accumulator tank, heating workshops, such drying-plant, etc.</p>
--	--	--	---

5.3.5 Fuel type setting: PELLET - WOOD

			<p>VIGAS DPA is semiautomatic boiler for combustion of pellets and wood. If using fuel „WOOD“ choose symbol „“ . For fast access to fuel type use round driver. See chapter 5.</p>
--	--	--	--

5.3.6 Automatic switch from „WOOD“ to „PELLETS“ setting

			<p>When you select "AUTO" will occur after burning out of fuel "wood" and flue gas temperature reaches end (see Sec. 5.3.2) to automatically transition to fuel "pellets" and the subsequent continuation of burning. In "Auto" mode is recommended temperature shut-end 50°C. When connecting the ACCU tank, the minimum temperature shutdown automatically moves to the required temperature of the boiler. If elected, "OFF" will occur after the end temperature for the boiler and the statement "END".</p>
--	--	--	--

5.3.7 Minimum temperature in the accumulation tank set-up

			<p>Setting the minimum temperature in the ACCU tank. The display is active only if the selected hydraulic diagram of the ACCU tank (see 10.4). Setting range 25-70°C. If the boiler exceeds the desired temperature by 1°C. there is a transition to the state of the boiler setback . The re-boiler is heating up and when the temperature drops in ACCU tank set value for example. 40°C (for fuel "wood" and fuel "pellets").</p>
--	--	--	--

5.3.8 Discharge fan speed setting

		on	<p>In case, the boiler is equipped with discharge fan (see chap.10.1.3), it can be used in permanent mode to increase chimney effectiveness. It is possible to control speed between 30% and 100% or complete shut down by „OFF“ symbol.</p>
--	--	----	--

5.3.9 Display brightness adjustment

			<p>Select figure for display brightness. This figure is possible to adjust from 0 to 100.</p>
--	--	--	---

5.3.10 Display contrast adjustment

			<p>Select contrast figure of the display. This figure is possible to adjust from 16 to 24.</p>
--	--	--	--

5.3.11 Adjustment of scrolling information line

		Roll	<p>By pressing „yes“ information line offers current boiler figures shown on display (pic.7), e.g. boiler power, boiler temperature, gas temperature, etc. By pressing „no“ choose figures for information line ▲ ▼.</p>
--	--	-------------	--

6. BOILER TEMPERATURE SETTING OF OUTPUT WATER

By pressing „ENTER“ button for 2 seconds at any time. Basic configuration of the boiler offers heating temperature setting from 70 °C to 85 °C.

2sec

7. TIME SETTING

Please set-up time and date when boiler firstly plugged in. Time is indicated in the upper left corner of the display. To recall parameter setting press „ENTER“ button at any time, then press ▲ button twice.

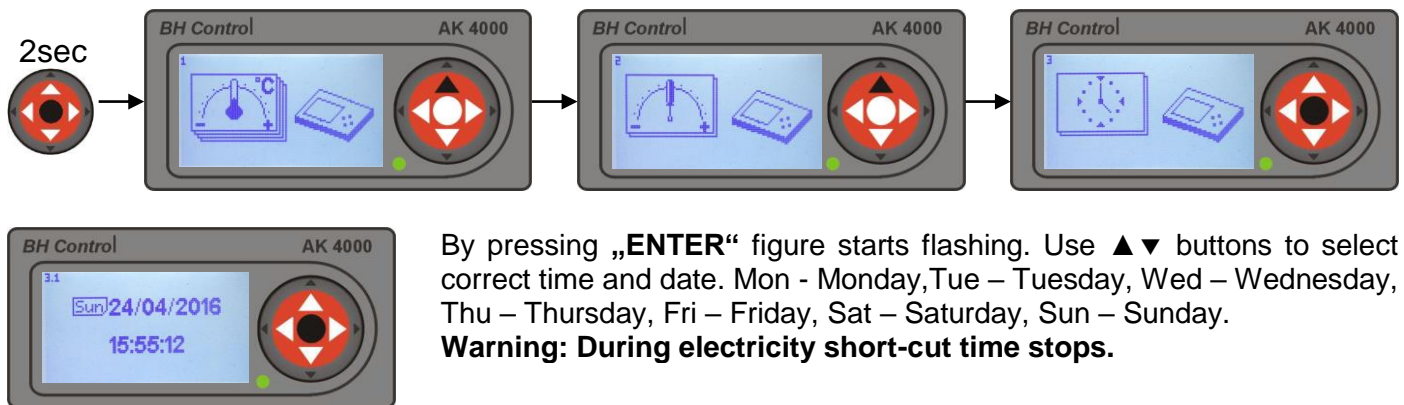

8. HARDWARE AND SOFTWARE INFORMATION

To recall information press „ENTER“ at any time and press ▼ button. Confirm by pressing „ENTER“. Use buttons ▲▼ to choose modul and confirm by pressing „ENTER“. display will provide information regarding selected module: AK4000D – Display, AK4000S – Power board unit, AK4000L – Lambda board module, AK4000EP – Pellet expander.

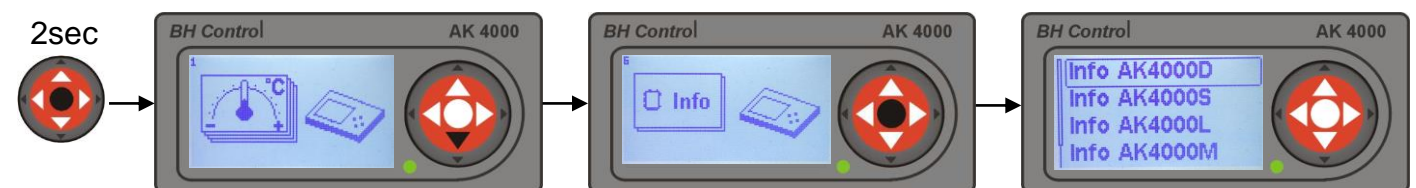

9. ERROR MESSAGES

To recall error message press „ENTER“ button at any time and press ▼ button two times. Confirm by pressing „ENTER“ button and error message appears on the display.

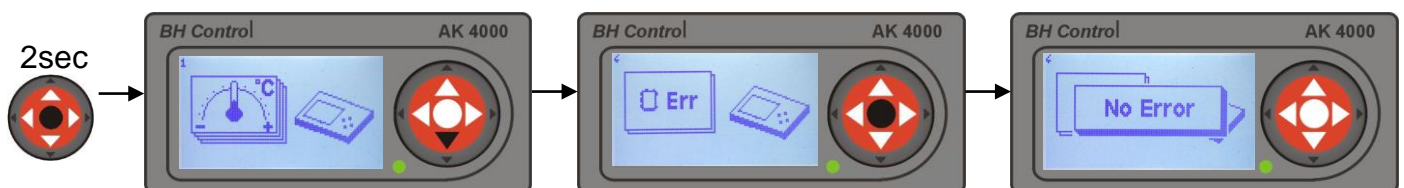

Error free running: **Green LED light**

Error: **Red LED light**

Error notifications and solutions are described in chapter „15. PROBLEMS, CAUSES, SOLUTIONS“.

9.1 STB error (boiler overheated)



„STB“ failure is caused by boiler overheating. Aktivovana sa tepelná poisťka. When this happens, the thermal fuse is activated and fan is disconnected from the power supply (pic. 3/7). Boiler can be only switched on if STB fuse is reset manually (picture), when boiler temperature drops down to **60°C**. To switch on the boiler press „ENTER“ button.



10. SERVICE SETTINGS USING PASSWORD PIN 0000

Using password PIN 0000 can be applied only in special cases. In service settings you can select type of boiler, hydraulic schema, etc. Mode for service setting „PIN 0000“ can be recalled by pressing „ENTER“ button at any time, then press ▲ and hold ◀ for 4 s. „PIN 0000“ will appear. Press „ENTER“ button 4 times. Service setting symbol will appear on the display. Press „ENTER“ and select service operation using ▲▼ buttons.

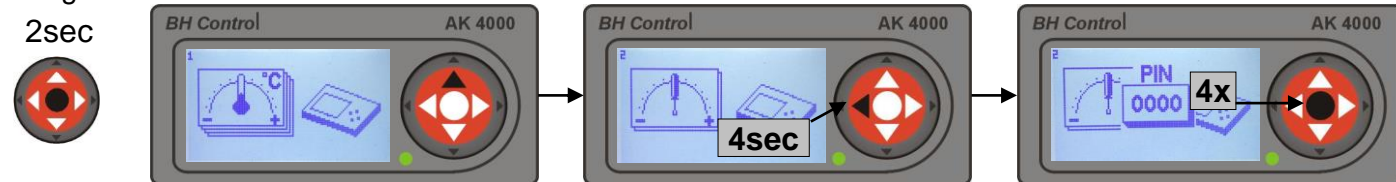

10.1 SERVICE SETTINGS

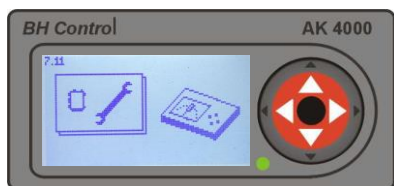

By pressing „ENTER“ service settings can be recalled. Using buttons ▲▼ choose parameter, by pressing „ENTER“ figure starts flashing.

WARNING

Display unit AK 4000 is used to operate all type of VIGAS boilers. It is important, that software setting is identical with boiler type. When boiler is „OFF“ display unit shows type of the boiler compliant with boiler nominal power (pic.7/4).

For proper boiler operation, type of the boiler must be always identical with production label.

Always check if AK4000 display unit is replaced!!!

10.1.1 Boiler type setting

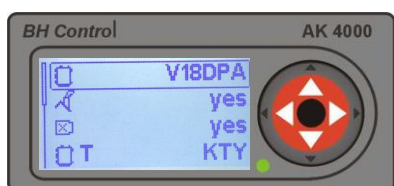

Offers to choose boiler type. Type of the boiler must be identical with production label.
 Label: V18 – boiler power, TVZ – hotair boiler, UD – wood-coal, DP – wood, pellets, DPA – wood-pellets automatic, L – Lambda.

10.1.2 Exhaust gas thermometer option

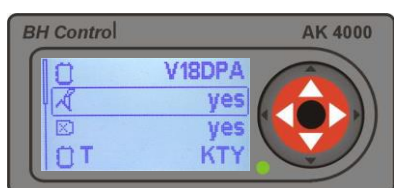

When exhaust gas thermometer is damaged, it is possible to disconnect. It is possible to run boiler without thermometer. Water temperature will be used to shutdown the boiler.
yes – boiler with thermometer, **no** – boiler without thermometer

10.1.3 Discharge fan option

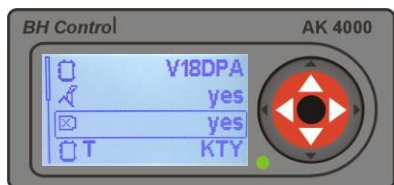

Discharge fan is an optional accessory of the boiler. After connection to the boiler and control unit AK4000 it is necessary to select option „yes“.
yes – boiler with discharge fan
no – boiler without discharge fan

10.1.4 Boiler thermometer type setting



Offers selecting two types of boiler thermometers:
 1. Standard : Type KTY
 2. Alternative : Type PT1000

10.1.5 Maximum boiler temperature setting



MaxT Maximum boiler temperature setting can be selected between 75 °C and 90 °C. Upper figure is used for boiler with accumulator tank.

10.1.6 Minimal temperature setting for boilers with accumulation tank

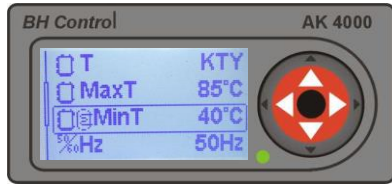

MinT Setting the minimum temperature in the ACCU tank. The display is active only if the selected hydraulic diagram of the ACCU tank (see 10.4). Setting range 25-70°C. If the boiler exceeds the desired temperature by 1°C. there is a transition to the state of the boiler setback . The re-boiler is heating up and when the temperature drops in ACCU tank set value for example. 40°C (for fuel "wood" and fuel "pellets").

10.1.7 Power supply frequency setting



50/60 Hz Power supply for EU is 50 Hz ,USA and Canada use 60 Hz. If you are not aware of used frequency select AUTO. Incorrect frequency can cause time error.

10.1.8 Temperature unit setting



Temper. unit Choose temperature unit. Option are:
°C - Celsius
°F - Fahrenheit

10.1.9 Summer time setting

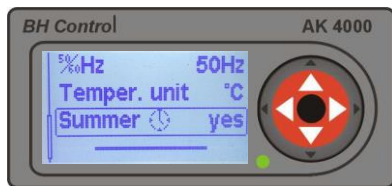







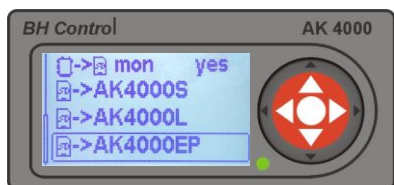





Summer Offers setting of automatic switch to the summer time.

10.2 MODULE SETTINGS AK 4000M

When necessary, it is possible to connect AK4000 control to the module AK4000M (pic.8). This module allows to upgrade and backup data maintenance of the boiler control unit. The module is equipped with data to make it possible to connect to BH BUS power board and USB to the PC.



pic.8

 →  config	To load a new configuration (connection schematic). Mainly used for systems controlled by EXPANDER AK4000E, where it is possible to load personal connection schematics.
 ←  config	Current configuration back-up. It is used for boiler monitoring. It is advised to perform before monitoring.
 →  firmware	To load firmware (boiler operating software).
 Erase	To delete information from module AK4000M.
 →  mon	Boiler monitoring - to save basic information of the boiler into memory module AK4000M. Before monitoring it is necessary to backup current configuration  ←  config. Data is saved every 3s. Data control will be realized by producer.
 → AK4000S	To download firmware into the power board AK4000S
 → AK4000EP	To download firmware to pellet expander AK4000EP

10.3 SERVICE CONTROL FUNCTIONS

In service settings the functions of each boiler’s components can be checked according to the symbols indicated on the display. By selecting component and pressing „ENTER“ button the function will be activated. Displayed components depend on the boiler’s configuration.

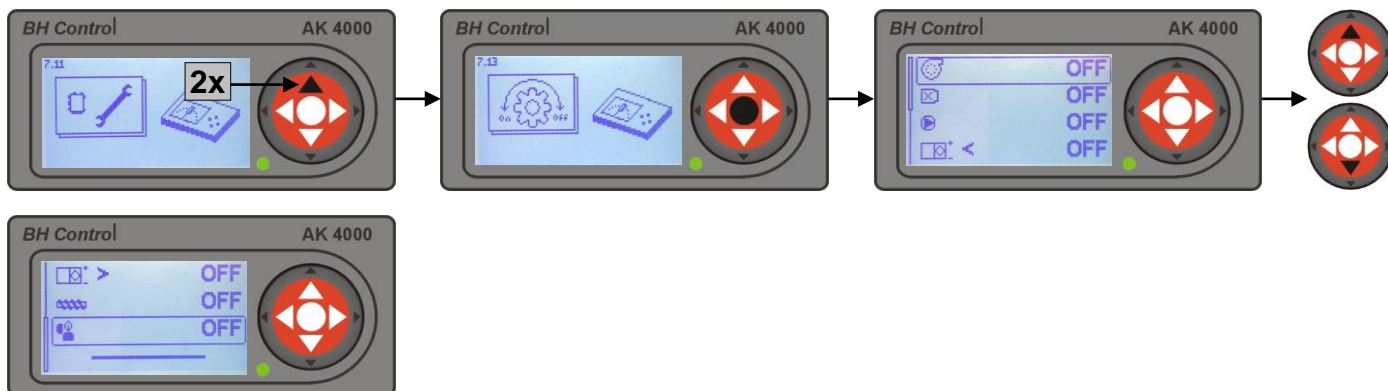

10.4 HYDRAULIC SCHEMA SETTING

By modification of hydraulic schema connection will also be changed the control of the pump output and boiler configuration. Therefore, it is very important that software settings for the hydraulic schematic is identical with existing boiler installation in the central heating system. In the basic memory of the control unit are 5 basic schemas and schemas intended for operating with the Expander AK4000E. On demand, it is possible to add Expander schemas via AK4000M module (pic.8). Updated schemas for Expander AK4000E can be found on www.vigas.eu

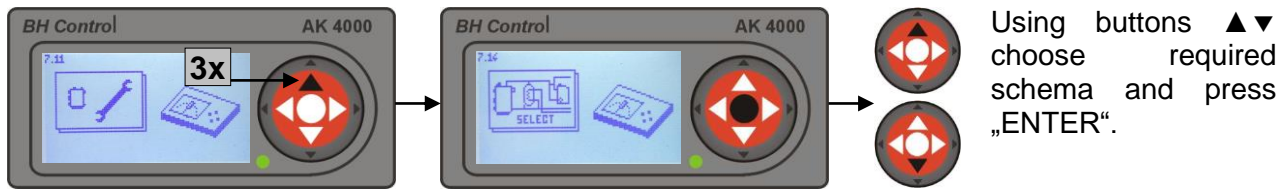

10.4.1 BASIC CONNECTION SCHEMAS

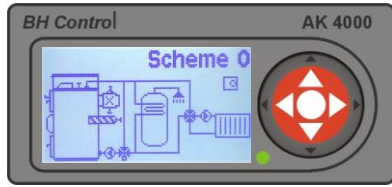

Schema 0 for (basic schema/BS-1) to protect from low-temperature corrosion, a three-way thermostatic valve ESBE is used (60°C). Water regulation for central heating is secured by 4-way mixing valve with manual control. For boiler heating, a combined tank is used. Both pumps must be connected to power board AK4000. Contact T3 of power board AK4000S is used for connection of room thermostat (see 20/B2 and 16.4.)

Attention:
Recommended schema for VIGAS DPA.

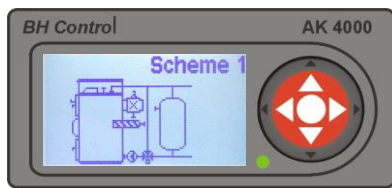

Schema 1 for (BS-3) shall be used with accumulator tank. To protect from low-temperature corrosion, a three-way thermostatic valve ESBE is used (60°C). Pump shall be connected to power board AK4000. Contact T3 of power board AK4000S is used to connect KTY sensor, to monitor tank temperature.

Attention: It is not possible to connect room thermostat with Schema 1. It is recommended to control the room thermostat by pump.

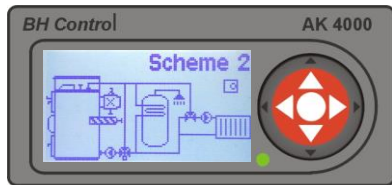

Schema 2 for (BS-2) Scheme is the same as scheme 0. To control water temperature for central heating, the 3-way mixing valve is used, which is operated manually.

Attention: Combines water tank must be used together with 3-way mixing valve.

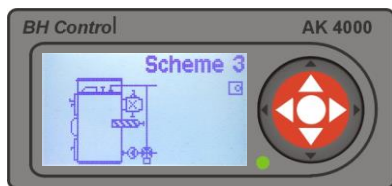

Schema 3 to protect from low-temperature corrosion, a three-way thermostatic valve ESBE is used (60°C). Pump must be connected to power board AK4000. Contact T3 of power board AK4000S is used for connection of room thermostat (see 20/B2 and 16.4.)

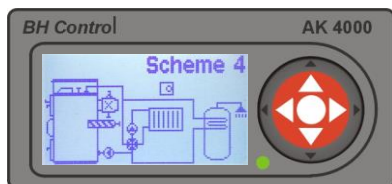

Schema 4 is designed for manual control with 4-way valve. For boiler heating, a combined tank is used. Both pumps must be connected to power board AK4000. Contact T3 of power board AK4000S is used for connection of room thermostat (see 20/B2 and 16.4.)

Recommendation: Connection without 3-way thermostatic valve does not secure sufficiently water temperature to 60°C. In order to expand the lifespan of boilers, it is recommended to use Scheme 0.

10.4.2 Connection schemas with EXPANDER AK4000E

Expander AK4000E complements the AK4000 boiler control unit. It enables the possibility to control the central heating system unit circuits, including regulating the supply water temperature, using different heating sources. Use of indoor thermostat and equithermic control (based on external temperature) or in combination, enables control of the central heating. Expander AK4000E is supplied in sets. According to the particular schematic connection, it is supplied as: basic set (order no. 5001), double set (order no. 5002) and triple set (order no. 5003). After verifying the connection schemes of the Expander, service settings will be supplied with unit settings for the central heating system and hot water supply. (Detailed description given in EXPANDER AK4000E service guide).

Technical requirements for optional accessories:

(To specify parameters of the pump and mixing valve with servomotor consult with technician specialist!)

1. Pump 230V/50 Hz.
2. Servounit 230V/50 Hz opening period 60 – 240 s.
3. Pump to be installed cca 0,5 m after 4-way valve.
4. Max. el. current for one Expander 3A.
5. Additional thermometer install cca 0,5 m after pump.
6. External thermometer install on the northern side of building.
7. Room thermostat (Potential free contact).

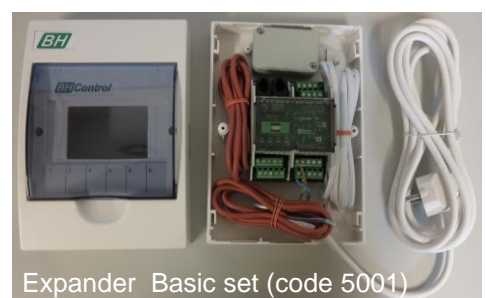

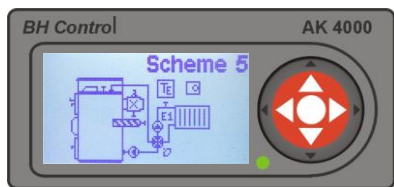

Schema 5 used with one heating circuit for floor or radiator. Central heating temperature can be controlled according to external temperature, room thermostat or by combination of both. The boiler pump and central heating pump are controlled separately. Boiler protection against low-temperature corrosion provides 4-way valve with servovinit.

Use: Expander basic set (code 5001).

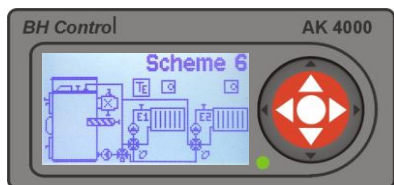

Schema 6 with two separate heating circuits controlled by servovinit. Option to choose floor or radiator heating or combination. Central heating temperature can be controlled according to external temperature, room thermostat or with combination of both. The boiler pump and central heating pump work separately. Boiler protection against low-temperature corrosion provides 3-way thermostatic valve (60°C).

Use: Expander double set (code 5002).

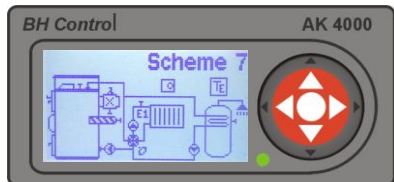

Schema 7 for (Basic scheme expander (BSE 1)) used with one heating circuit controlled by servovinit for floor or radiator heating. Heating of domestic water supply is controlled by pump. Temperature of central heating is controlled by external temperature, room thermostat or by combination of both. Boiler protection against low-temperature corrosion provides 4-way mixing valve.

Use: Expander basic set (code 5001)

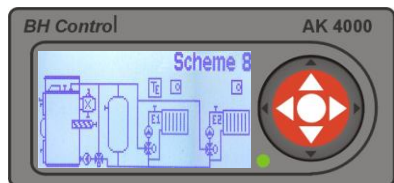

Schema 8 with two separate heating circuits and accumulator tank. Option to choose floor or radiator heating or combination of both. Temperature of central heating can be regulated according to external temperature, room thermostat or by combination of both. Boiler protection against low-temperature corrosion provides 3-way thermostatic valve (60 °C).

Use: Expander double set (code 5002) + 1 x sensor KTY (code 3032).

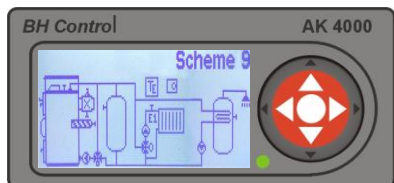

Schema 9 for (BSE-2) with one heating circuit of central heating system using servovinit with accumulator tank. Heating of warm domestic water is controlled by pump. Water temperature can be regulated on the basis of external temperature, room thermostat or the combination of the two. 3-way thermostatic valve (60°C) secures the protection of boiler against low-temperature corrosion.

Use: Expander basic set (code 5001) + 1x tank sensor KTY (code 3032)

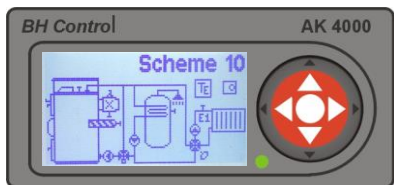

Schema 10 is used with one heating circuit controlled by servovinit for floor or radiator heating. Heating of domestic water supply is controlled by pump. Temperature of central heating is controlled by external temperature, room thermostat or by combination of both. Boiler protection against low-temperature corrosion provides 4-way mixing valve.

Use: Expander basic set (code 5001)

10.5 INFORMATION LINE

Display information line enables indication of particular information about the AK4000 control unit system. By pressing ▲▼ choose required data and press „ENTER“. Marked data ☑ will be displayed on the information line (chap.3.5).

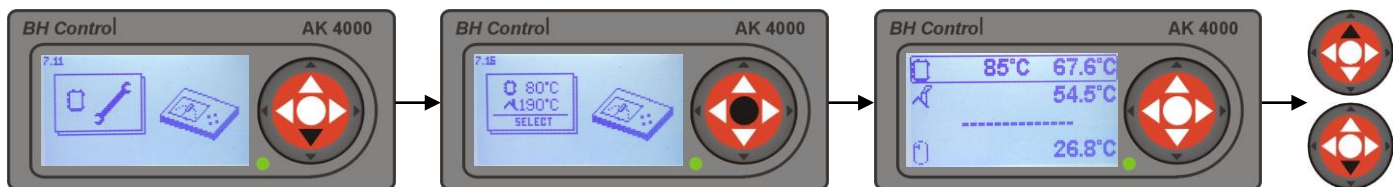

10.6 INPUTS AND OUTPUTS ELECTRICAL CONNECTION OF CONTROL UNIT AK 4000

The control unit AK 4000 offers to view connection of both, inputs and outputs according to current configuration.

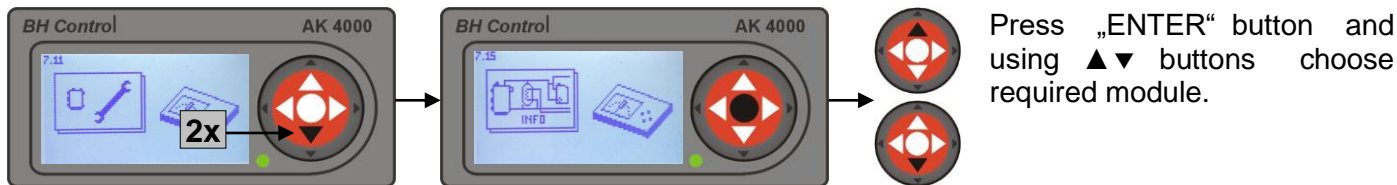

Press „ENTER“ button and using ▲▼ buttons choose required module.

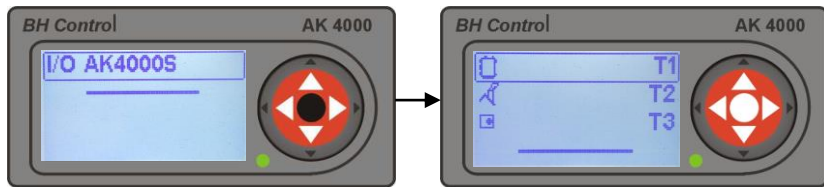

I/O AK4000S – power board connection	
	T1 Boiler thermometer T1
	T2 Exhaust gas thermometer T2
	T3 Room thermostat T3
	T3 Or accu. Thermometer T3

In case of connecting „EXPANDER“, the options will automatically extend (AK4000E1)



I/O AK4000E1 – connecting for EXPANDER 1			
	Room thermostat at T1	1 ON R1	Phase servo-unit „OPEN“ to R1
1 T2	Thermometer UK1 to T2	1 OFF R2	Phase servo-unit „CLOSE“ to R2
	Outside thermometer to T3	1 R3	Pump voltage UK1 to R3
	Utility water thermometer to T4	R4	Pump voltage utility water to R4

11. OPERATING INSTRUCTIONS

11.1 Prior to the boiler operation carry out necessary actions !

- Read and become fully familiar with the operating instructions, manual and the AK4000 electronic control.
- Check water pressure in central heating system (max. 3 bar).
- Check safety electrical components (safety drain valve, safety valve)
- Connect electrical components (pump, discharge fan or room thermostat, etc.)
- Check metal panel covers.
- Check power supply connection (230V/50 Hz) ,
- Prepare a sufficient amount of fuel for the burning and heating phase.
- Check fireclay bricks and grate for pellet burning according to pic. 3, which could be out of space due to transportation
Check boiler connection to the chimney
Straighten container with adjustable screws.
- Connect boiler to power supply (230V/50Hz) – display activated.

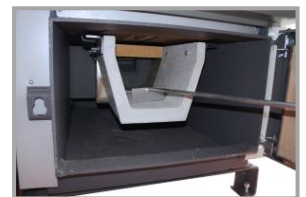

11.2 BOILER HEAT-UP fuel „PELLETS“

- Check if upper and bottom door are shut, as well as chimney flap,**
- Refill the container with required amount of pellets,
- Set up required water outlet temperature (chap. 6),
- By pressing „ENTER“ switch on the boiler (chap. 4.1.1),



11.3 POWER CONTROL FUEL „PELLETS“

After pellets ignite boiler starts burning mode. This mode directly controls boiler power according water temperature on output or directly by room thermostat (if connected). Pellets are transferred through tourniquet and feeder directly to burner. Container capacity is sufficient to operate for 2 - 7 days, according to required performance. Ultrasound sensor is placed in the container to detect minimum level of pellets. Time period for automatic shutdown of the boiler ca be viewed on the display (chap.4.1.4).

WARNING !

During electricity short-cut is not possible to run the boiler. When electricity is reactivated boiler will got into automatic mode of fuel heat-up to continue its burning process. It is easy to check fuel heat-up by opening the chimney flap or through upper door. Do not forget to close after checking.

ATTENTION !

Refill container on time, to avoid complete emptying of feeder and tourniquet.

11.4 BOILER HEAT-UP fuel „WOOD“

- prepare sufficient amount of dry wood for heat-up,
- open chimney flap using rod (pic.3/3),
- open upper door (pic.3/2) and place paper on ceramic nozzle, make sure some paper gets into bottom combustion chamber (pic.3/9), than place small timber, logs and fill up the rest of the chamber (pic.3/27),
- close upper door and slightly open bottom door (pic.3/13) to boost heating up. (pic.3/4). If discharge fan available switch on to use for heating up,
- approximately after 10 – 15 minutes, when fire base is created, closed bottom door and chimney flap.
- by pressing „ENTER“ boiler is „ON“. Boiler starts combusting and automatically control its power according to required temperature for fuel „WOOD“,
- do not forget to check upper door, lower door and chimney flap.**

WARNING !

Do not open lower or bottom door if not necessary to avoid smoke leakage into the boiler room area. Refuel only shortly before burn-out (pic.3/4).





11.5 REGULATION AND POWER CONTROL.

Fuel inside the boiler moves gradually towards ceramic nozzle. Ash falls through nozzle and remains in combustion chamber. Boiler power is controlled automatically according to set temperature of output water.

Attention: In case of electricity short-cut or defect of automatic control unit, it is possible to continue heating (only available for central heating systems with gravitation flow, usin fuel „WOOD“): open chimney flap and slightly open bottom door. Using this option requires often temperature checking and less fuel adding. If boiler refilled to its capacity, may cause boiler overheating easily!

11.6 REFILL THE BOILER WITH FUEL

- open chimney flap using rod (pic.3/3),
- by pressing „ENTER“ shortly, select „“,
- carefully open upper door, to release the smoke from chamber,
- through upper door (pic.3/2) refill required amount of fuel,
- close upper door (pic.3/2) and chimney flap (pic.3/3),
- by pressing „“ finish fuel refilling.

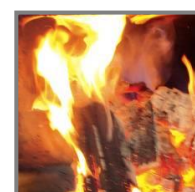

Burning base



Bottom door open

Wood characteristic table

Wood	Fuel efficiency [MJ/kg] 20% humidity	Fuel efficiency [MJ/kg] 25% humidity	Hardness *	weight [kg/m ³] 25% humidity
Poplar	12,9	12,3	1	530
Fir	15,9	14,0	1	575
Spurce	15,3	13,1	1	575
Willow	16,9	12,8	1	665
Pine	18,4	13,6	1	680
Alder	16,7	12,9	2	640
Birch	15	13,5	2	780
Maple	15	13,6	4	660
Beech	15,5	12,5	4	865
Ashen	15,7	12,7	4	865
Locust	16,3	12,7	4	930
Oak	15,9	13,2	4,5	840

[kg/m³] = [kg/fm], fm – fullmeter, * (1 very soft...5 very hard)

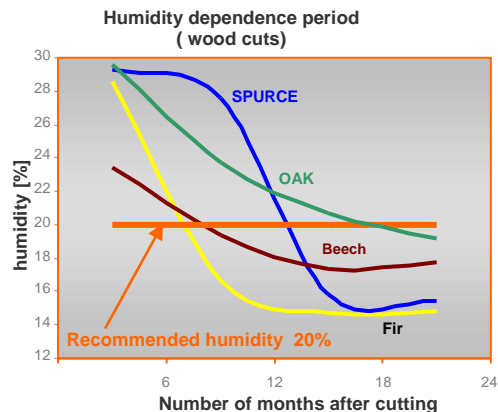

Important information !!!

- Use only recommended fuel.
- Do not overload the boiler with fuel during mid-season period, to avoid tar production.**
- When refilling the boiler, make sure that fuel does not get between mounting and chimney flap. This would stop chimney flap from proper closing.
- It is important to lay wood properly, to allow proper closing of the upper door. Forced closing can damage heatproof lining.
- It is recommended that only person over 18 years, should operate the boiler.

11.7 BOILER CLEANING

Optimal wood burning and keeping minimum temperature of the reverse water at 60°C will ensure that the gasifying chamber and exchanger will only soot little. Using damp wood may cause water to condense on the walls of the combustion chamber, which creates tar on the surface.

Gasification chamber cleaning

It is necessary to remove tar from the gasification chamber once a week. It is recommended to burn it off with the upper door and chimney flap open. If there is extra ash which did not fall through the nozzle (pic. 3/9) into the fireclay combustion chamber, this should be removed from time to time. Fuel bunker will increase to the original size and primary air flow through nozzle will be enhanced.

Combustion chamber cleaning

It is recommended to sweep out ash and dust that has fallen and settled in the combustion chamber once every 3-5 days. When using pellets, clean the pellet burner once a month.

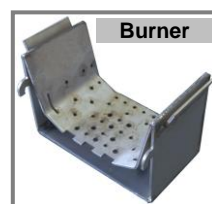

NOTICE !

Pellet burner is placed together with firebricks inside combustion chamber. Please take care for burner to be cleaned and placed to its initial space.

Exchanger cleaning

It is necessary to clean exchanger pipes once a month using the fire rake (round plate). Than remove ash from lower part of combustion chamber through bottom door.

Recommendation: If the exchanger is not cleaned regularly it will become clogged with tar. Do not use solvents. The boiler must be cleaned whilst it is hot! Heat boiler to approx 80°C (without fan) through open upper door and chimney flap. Then close the flap and door. Using gloves, carefully open exchanger cover. Clean clogged pipes with relevant accessories. After cleaning, close exchanger cover and let the boiler burn / gasify for approx. 5 hours at maximum performance, in order to get rid of any remaining tar. Avoid this situation in the future.

WARNING: Boiler room area must be permanetly ventilated at maximum during cleaning time.

Step 1



Step 2



Step 3



12. BOILER MAINTENANCE AND REPAIRS

The contractor provides regular service and boiler maintenance. During operation it is necessary to check water pressure, door seal, chimney flap tightness, exchanger cover seal, flue cleanliness and fan performance.

Warning!

When boiler switched off at the end of heating season clean properly combustion chamber. To avoid residual humidity leave the bottom door open together with chimney flap. Do not leave pellets inside container and feeder to avoid wetting and desintegration.

12.1 DOOR TIGHTNESS

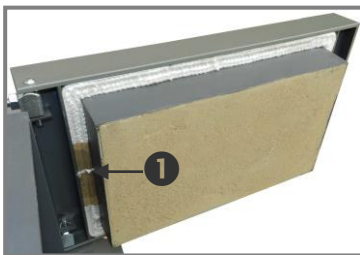

Door is stabilized by 3 points – 2 rotary pins and door shutter. If the door is tightless, there is possibility to set by shutter or hinge side. Slightly turn hinge to release and turn hinge screw and then move door in desired direction. Number „1“ is area where gasket is joined.

12.2 CHIMNEY FLAP TIGHTNESS



When cleaning exchanger pipes (pic.3/23) make sure that flap area is clean, as well as flap itself (pic.3/15). Flap leakage can decrease boiler power.

Notification: Flap is secured by 2 bolts with loose fitting. **Do not fasten!!!**

12.3 CERAMIC NOZZLE



The heatproof nozzle is a block made of heat-proof concrete and its use is to mix gases with secondary air to ensure efficient burning. The nozzle is located on the water cooling rack. The nozzle is surrounded with heat-proof concrete at the same height as the nozzle. The life of the nozzle is dependent on mechanical damage as a result of fuel loading or stoking the fire. Therefore, the nozzle is considered as a spare part. Cracks noticed on the nozzle are not a reason to change the nozzle. It is only necessary to change the nozzle if it is dropped or is broken. Remove the pieces of the broken nozzle and replace with a new nozzle ensuring that it is inserted and fits into the opening.

12.4 SECONDARY AIR FLAPS SETTING



Flap position affects quality of combustion. The correct proportion between primary and secondary air is set by screws „1“. Ideal set up of secondary air is 1,5 turn of screw „1“. If you need to change or check setting, follow these steps:

Step 1: Loosen the bolt on screw „1“

Step 2: Screw „1“ turn all the way to the boiler body,

Step 3: Loosen the screw for 1,5 turn (ideal),

Step 4: Tighten the security bolt.

TURNS	FUEL
0	Not recommended
1	Humid fuel
1,5	Humid softwood
2	Dry softwood
2,5	Dry hardwood
2,5 and more	Very dry, hard or small timber

12.5 PELLET BURNER



The pellet burner is designed to burn pellets by classic combustion. The burner is made of heatproof steel. It is necessary to replace if worn out or shapeless

12.6 TOURNIQUET AND PELLET FEEDER

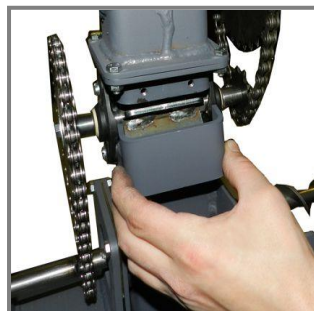

Chamber pellet dispenser (tourniquet) is the device designed to transfer required amount of pellets into the feeder and to create separate air space above feeder.

The construction of the driver using chain transmission will avoid pellets to catch fire inside container. This design also provides easy checks and cleaning, if tourniquet is jammed with unwanted object.

12.7 AIR DISTRIBUTOR, FAN, SERVO-UNIT

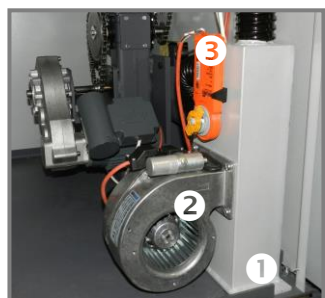

Air distributor „1“ together with servo-unit „3“ is device designed to provide automatic air transfer created by blower fan „2“ during fuel switch from „WOOD“ to „PELLET“ and vice versa. Servo-unit position can be view on the display : , : . When boiler is shut down or switched off servo – unit moves to the position : 100% „PELLET“.

IMPORTANT !

It is necessary to clean fan blades once per year!

12.8 CHIMNEY EXHAUST GAS THERMOMETER



For proper operation of exhaust gas thermometer is very important its cleanliness. When cleaning heat exchanger always gently wipe away dust from thermometer.

Important! Thermometer must be in accurate position! Its metal ending must match with its case. (Shifting the position can significantly change displayed value of exhaust gas temperature).

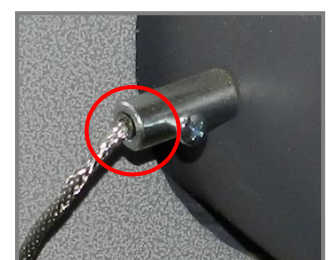

12.9 CLEANING OF AIR DUCT SYSTEM

The clearness of air pipes is the basic requirement for the proper combustion of the boiler. It is necessary to clean pipe system at least once per year. The combustion takes place on the basis of primary and secondary air duct. The boiler construction allows by gradual dismatling to access all required area for cleaning.

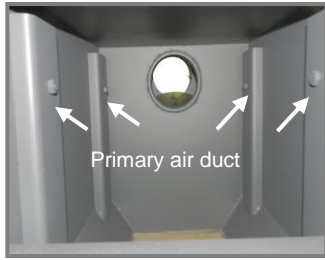

Primary and secondary air duct cleaning:

- Remove front cover panel (pic. 3/8).
- Remove secondary air steel plate.
- Use vacuum cleaner to clean primary and secondary air duct.
- Remove and clean primary air duct.

13. ACCESSORIES AND ASSEMBLY

13.1 SAFETY DRAIN VALVE

Cooling safety exchanger usage:



1. Safety drain valve
2. Hole for insert
3. Discharge

Cooling safety exchanger together with safety drain valve Honeywell TS 131 provides boiler protection against overheating during a power cut. If forced circulation will shut down the pump and then the water flow in central heating system will stop. In case, there is no option to use automatic gravity flow or minimum 5kW consumption, boiler can overheat.

Assembly of safety drain valve TS 131:

Valve TS131 screw on to the mouthpiece „1“. Safety exchanger must be water tight (closing water prior flowing). The second outlet must be directed into the drain. Insert the thermal sensor 1/2" into mouthpiece „2“.



Features:

Safety drain valve opens according to boiler outlet water temperature. When the temperature reaches 95 °C, valve opens. Overflowing water from communal water supply absorbs boiler temperature and avoids overheating or possible boiler damage. This system is in accordance with standard STN EN 303-5/2012.

Notification:

- Safety drain valve is not part of the boiler.
- The assembly of the drain valve and thermal sensor is necessary to perform before the central heating system is filled with water.
- The pressure of cooling water should not be dependent on voltage.
- Do not loosen 3/4" inserts „2“, may cause water leakage. There is aluminium washer „4“ with rubber insert „3“, that seals copper pipe „1“ inside mouthpiece „5“. If water leakage occurs tighten insert 3/4" no. „2“.

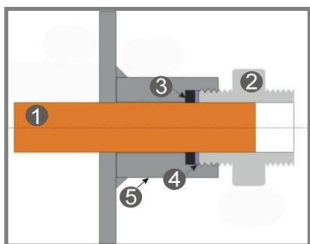

13.2 ROOM THERMOSTAT



Connecting room thermostat to the boiler will provide more comfort for operator. It shall be connected to the power board unit AK 4000S. Standard version has jumper on T3 terminal. **Contact element is potential free.**

If T3 is disconnected, display shows „OFF“ symbol for room thermostat. In such case, the fan will gradually shutdown. Boiler condition is indicated by symbol „“. If the room thermostat is „ON“ boiler starts again.

Attention: If the room thermostat is disconnected for more than 1 hour, blowing fan will operate at short intervals to keep firebase active.

13.3 DISCHARGE FAN

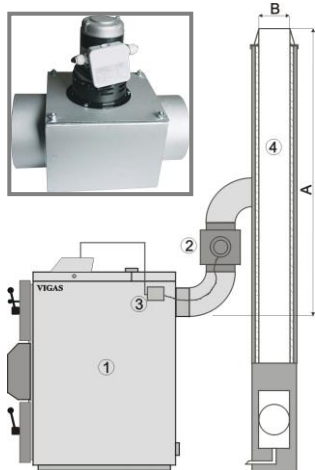

Discharge fan „2“ is designed to eliminate smoke in the boiler room area during refueling VIGAS boiler. In case chimney does not comply with minimum parameters „A“ a „B“ it is recommended to install discharge fan. This shall be installed between chimney flue and chimney body. Fan capacitor „3“ shall be mounted to the side. It shall be connected to the power board unit AK 4000S. It comes in two sizes depending on chimney diameter.

V25 (code 0507) – for VIGAS 12DPA, VIGAS 16,18DPA, 25, 29 UD.

V80 (code 0508) – for VIGAS 40, 60, 80, 100.

BOILER TYPE	Min A	Min B
VIGAS 12 DPA, VIGAS 16, VIGAS 18 DPA, VIGAS 25, VIGAS 29 UD	8 m	160 mm
VIGAS 40, VIGAS 26 DPA	8 m	200 mm
VIGAS 60, VIGAS 80, VIGAS 100	12 m	200 mm

Drawing with parametres V25 a V80 available at: www.vigas.eu, www.vimar.sk

13.4 CIRCULATION PUMP AND 3-WAY THERMOSTATIC VALVE



The basic version of electronic control unit without expander allows to connect pump with AK 4000S power board. The operation of pump depends on selected hydraulic schema and boiler temperature. Using two methods of pump control, by pulse or permanent running.



Pulse running allows the pump to go on and off within specific time interval. Pump activity depends on the boiler output temperature. The main advantage is protection of the boiler against low-temperature corrosion.

Permanent running is used with 3-way thermostatic valve or Ladomat installation. See chap. 10.4.

The pump operation is indicated by a flashing symbol on the display.

13.5 COOPERATION OF VIGAS BOILER WITH ACCUMULATION TANK



As standard in the boilers VIGAS, one load is sufficient for 12 hours of operation which means that it uses less than 30% of rated output. In view of the life of the boiler it is preferred that the boiler operates at least at 50% of rated output. If the boiler VIGAS is used with ACCU tank, 100% of rated output is used to achieve the desired boiler temperature. If there is current requirement for heating, 100% output of the boiler is divided into charging ACCU tank and heating. In this case, the tank is recharged by the excess output of the boiler. In view of the fact that the boiler and ACCU tank is hydraulically connected to each other, the temperature of the ACCU tank and the boiler rises to the desired temperature of the boiler together. After exceeding this temperature by 10°C, boiler goes into the attenuation  (0% boiler output). In this mode, heating and charging ACCU tank is managed solely by means of pumps. The great advantage of this system control is that in the attenuation mode, it is possible at any time to add the fuel to the boiler, without overheating of the ACCU tank, which in practice increases the time between fuel loading. The automatic re-heating up takes place only after the exhaustion of ACCU tank at the selected temperature  **MinT**. ACCU tank minimal temperature volume can be adjusted from 20°C to 70°C. After burning out of fuel and decrease of chimney temperature to the boiler set  **end**, the boiler will shut down. In a combined automatic boiler VIGAS 18 DPA, after burning out of fuel "wood" boiler will automatically switch to fuel "pellets" and continue heating another few days.

NOTE: For all hydraulic circuits with ACCU tank, there must be a thermometer for ACCU tank (code 3032) connected to regulation AK4000 and its location to insert at the top of the accu. tank.

14. LIST OF SERVICE CENTERS

In order to maintain quality and safety it is recommended to carry out boiler repairs by authorized service technician appointed by producer:

Pavel Vigaš - VIMAR, Příboj 796, 976 13 Slovenská Ľupča, Slovakia.

tel. 00421 48 41 87 022.

tel. 00421 48 41 87 159



email: vimar@vimar.sk

Current list of sales and service centers can be found on the website: www.vimar.sk , www.vigas.eu

15. PROBLEMS, CAUSES AND SOLUTIONS

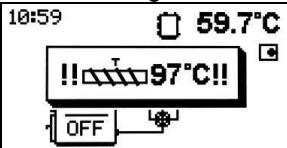
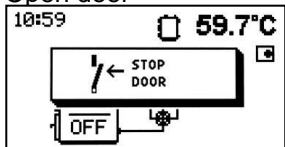
Problem	Cause/ Solution
During heating season boiler power decreased from previous period.	Used fuel was too humid. Clean pipes airway system. See chap.12.9. Clean fan blades. See chap.12.7.
When chimney flap closed, boiler does not perform and smoke appears.	Small amount of primary air. Clean primary air system.
Combustion chamber contains large unburned pieces of wood.	Nozzle hole enlarged. Replace nozzle. Check secondary air flaps. See chap.12.4. Decrease the temperature \nearrow end. See chap. 5.3.2.
Leakage of smoke after the door is closed.	Insufficient tightness of the door. Adjust the door. Check door tightness. Door seal needs to be reversed or replaced.
Unable to open chimney flap.	Chimney flap is stuck by tar. Increase the boiler operating temperature. Use dry fuel. Increase \nearrow end. See chap. 5.3.2.
After opening the upper door and chimney flap, smoke is dispersed in the boiler room.	Low chimney draft. Chimney diameter must be wider than diameter of boiler flue outlet. Fitting of discharge fan is recommended. See chap. 13.3.
Cracked fireproof lining.	Not defect Only separates combustion and gasification chamber.
Fan is not turning. After hand spin it starts running.	Defected start capacitor. Change fan capacitor.
Boiler is switched off, but fan is still running.	Damaged fan wiring. Neutral cable for fan is connected to the ground wire.
Pump is working, even if symbol  does not show pump in operation.	Damaged pump wiring. Neutral cable for fan is connected to the ground wire.
During ignition mode, pellets fail to ignite.	Defected ignition coil. Check ignition coil function.
During pellets feeding mode, feeder is not moving.	Check chain gear, check tourniquet, check motor gear. See chap.12.6.

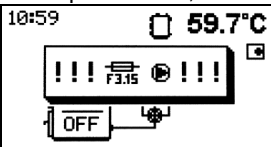
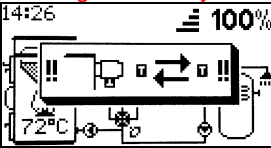
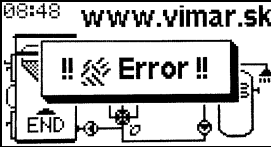
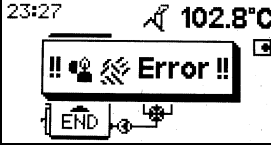
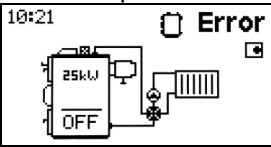
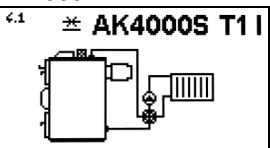
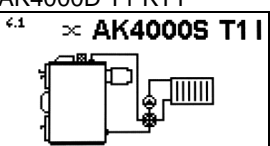
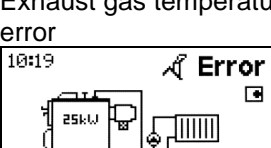
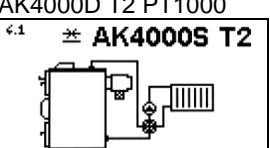
Error notification	Error identification	Cause/ Solution
Chyba Tmax Na displeji sa zobrazí výpis „MAX“ ak kotol prekročí teplotu 93 °C. Red control LED is flashing		<input type="checkbox"/> When temperature drops below desired temperature boiler starts running again.
STB error  Red control LED is flashing		<input type="checkbox"/> Boiler overheated – when boiler temperature drops down, reset STB manually. See chap. 9.1.
Overheated gearbox  Red control LED is flashing		<input type="checkbox"/> Overheating the motor gearbox above 80 °C will shut down the boiler. Check tourniquet, feeder against latching, etc.
Open door  Red control LED is flashing		<input type="checkbox"/> Security door contact. When open boiler shuts down. See contact D – D of wiring diagram AK4000EP. <input type="checkbox"/> Contact not used.

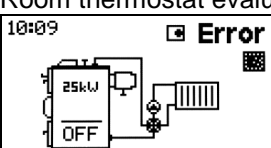
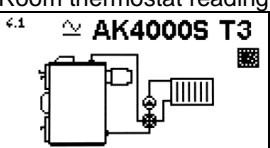
Error notification	Error identification	Cause/ Solution
<p>Interrupted fuse 3,15A</p>  <p>Red control LED is flashing</p>		<ul style="list-style-type: none"> <input type="checkbox"/> Interrupted fuse 3,15A, which connects boiler pump. <input type="checkbox"/> Check pump connection
<p>Warning of chimney thermometer</p>  <p>Red control LED is flashing</p>	<p>Warning is displayed when after ignition pellet flue temperature at 100% power boiler flue temperature does not exceed the captured at the end of the ignition to 2 minutes of 50°C</p>	<ul style="list-style-type: none"> <input type="checkbox"/> clogged chimney thermometer. . <input type="checkbox"/> open damper during ignition pellets. . <input type="checkbox"/> increase power correction (chap.4.2.1). .) <input type="checkbox"/> increase adjustment of the fan (chap.4.2.2). <input type="checkbox"/> Thermometer chimney ejected, cleaned and inserted back.
<p>Kontrola po zapálení peliet</p>  <p>Red control LED is flashing</p>	<p>The boiler shutdown occurs if pellets for ignition temperature of the flue at 100% power boiler flue temperature does not exceed the captured at the end of the ignition to 2 minutes. by 2 ° C.</p>	<ul style="list-style-type: none"> <input type="checkbox"/> clogged chimney thermometer. . <input type="checkbox"/> open damper during ignition pellets. . <input type="checkbox"/> increase power correction (chap.4.2.1). .) <input type="checkbox"/> increase adjustment of the fan (chap.4.2.2). <input type="checkbox"/> Thermometer chimney ejected, cleaned and inserted back.
<p>Pellet ignition error</p>  <p>Red control LED is flashing</p>	<p>Error appears when at the end of the ignition pellet chimney flue temperature does not exceed the captured at the beginning of the ignition at 2°C</p>	<ul style="list-style-type: none"> <input type="checkbox"/> Clean burner (pic.3/24) large amount of ash inside burner <input type="checkbox"/> Check pellet level inside container <input type="checkbox"/> Check ignition coil function (picr.3/35)
<p>Boiler temperature reading error</p>  <p>Red control LED indicator</p>	<p>Disconnected boiler thermometer AK4000D T1 KTY</p> 	<ul style="list-style-type: none"> <input type="checkbox"/> Disconnected boiler thermometer – check thermometer <input type="checkbox"/> Damaged thermometer – replacement required
	<p>Short circuit of boiler thermometer AK4000D T1 KTY</p> 	<ul style="list-style-type: none"> <input type="checkbox"/> Damaged boiler thermometer – replacement required <input type="checkbox"/> Short circuit of thermometer in the connection area - check
<p>Exhaust gas temperature reading error</p>  <p>Red control LED indicator</p>	<p>Disconnected exhaust gas thermometer AK4000D T2 PT1000</p> 	<ul style="list-style-type: none"> <input type="checkbox"/> Disconnected chimney thermometer – chek thermometer. <input type="checkbox"/> Damaged exhaust gas thermometer – replacement required
	<p>Short circuit of gas thermometer AK4000D T2 PT1000</p> 	<ul style="list-style-type: none"> <input type="checkbox"/> Damaged exhaust gas thermometer – replacement required <input type="checkbox"/> Short circuit of thermometer in the connection area - check
<p>Room thermostat evaluation error</p>  <p>Red control LED indicator</p>	<p>Room thermostat reading error</p> 	<ul style="list-style-type: none"> <input type="checkbox"/> Disturbance of room thermostat signal caused by induction of concurrent power supply

16. ASSEMBLY REGULATIONS

16.1 ASSEMBLY AND INSTALLATION INSTRUCTION

- Boiler can only be connected to the heating system with relevant thermal output capacity
- When using enhanced circulation, central heating system must offer option, in case of a power cut (shutdown boiler and pump) to ensure boiler minimum power at 5kW. This is provided by safety cooling exchanger together with Honeywell drain valve TS131.

Drain valve Honeywell TS 131 is additional component, it is not part of the boiler.

- In case, boiler is installed with accumulator tank, the minimum tank volume is calculated according to STN EN 303/5:2012 as follows: $V_{sp} = 15 T_B \times Q_N (1 - 0,3 Q_H / Q_{min})$

V_{sp} – volume of accumulator tank [L]	Q_N – nominal heating power [kW]	T_B – combustion interval [hours.]
Q_H – required boiler power - heating area [kW]	Q_{min} – minimum heating power [kW]	

- Minimum recommended volume of buffer tank for VIGAS 12DPA, 18DPA is 500 L, VIGAS 26DPA is 1 000 L.
- Boiler must be connected to the chimney correctly and shortest way. Chimney should not be occupied by any other devices. Chimney venting must be in accordance with STN 734201 and STN 734210.
- We do not recommend permanent connection to the water supply through inlet valve, in order to avoid increased pressure in the system. Maximum overpressure is 0,3 MPa.
- Boiler room must be properly ventilated.
- Boiler assembly and installation must be carried out by authorized technician.
- Boiler must be commissioned by authorized trained technician.
- Boiler does not require separate solid base.
- Minimum temperature of reverse water returning to the boiler shall be 60 °C. This condition shall be secured by thermostatic or thermoregulatory valve. Recommended manufacturer is ESBE: Type VTC312 (G1") up to 30kW boiler, type VTC511 (G6/4") up to 150kW boiler performance
- Boiler room must be permanently ventilated through min. 0,025 m² slot. Diameter for inlet and outlet must be similar.
- Boiler must be installed in the basic, usual surrounding in accordance with STN 33 2000-3.
- It is advised to follow safety and health regulations in accordance with current requirements notice no. 718/2002 Statute.
- It is strictly advise to follow required standards regarding flammability level of materials surrounding the boiler according to standard STN 73 0823:1983/z1 - Flammability degree of building materials.

16.2 ELECTRICAL EQUIPMENT CONTROL AND MAINTENANCE SAFETY REGULATIONS

The boiler operator person must follow relevant regulations and standards, as well as the following rules:

- While boiler in service, none of the following actions may be carried out.
 - DO NOT uncover the electronics, fan, thermostat.
 - DO NO change the fuse.
 - DO NOT repair damaged cables or insulation.
- Maintenance and repairs to the boiler with uncovered electrical equipment may only be done by authorized person, according to notice no. 74/1996 Statute.
- Before any interference with electrical equipment, it is necessary to unplug and disconnect power cord. Connection to power supply is only allowed after all cover panels are mounted back on the boiler.
- If any defect of electrical equipment occurs or boiler insulation is damaged, it is advised:
 - DO NOT touch any part of the boiler.
 - IMMEDIATELY unplug and disconnect the boiler from power supply.
 - TO CALL authorized technician in order to remove failure.

Except basic maintenance, it is strictly forbidden:

- To carry out any work on electrical equipment while boiler is plugged in.
- To touch defected electrical equipment, mainly damaged wire insulation, etc.
- To operate boiler while uncovered.
- To operate boiler with any defect on electrical equipment or installation.
- To repair damaged electrical parts of the boiler by person other than authorized and appointed by producer.

16.3 Recommended basic schematics with AK 4000 control.

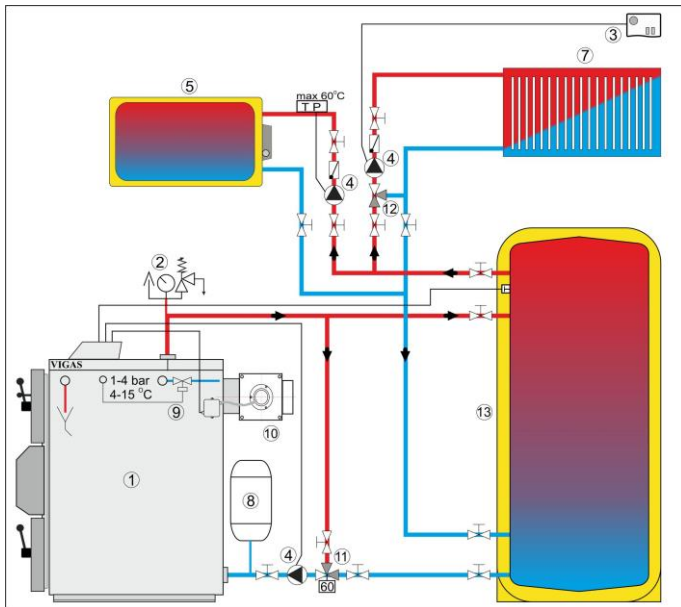
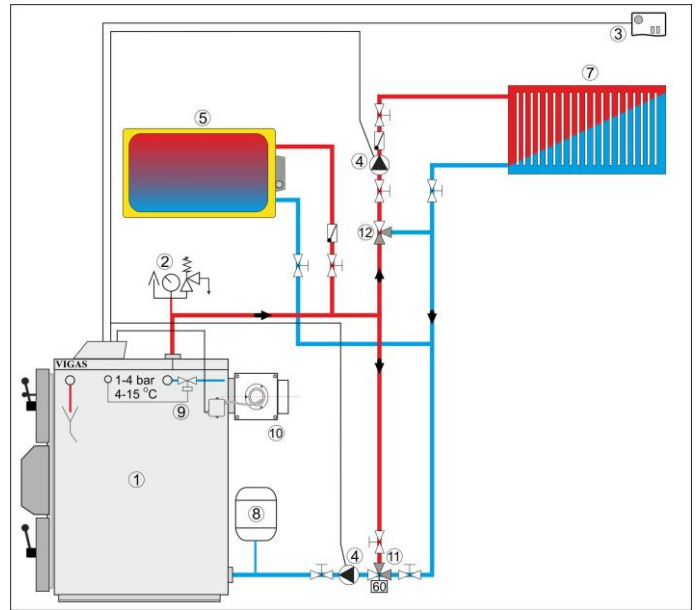
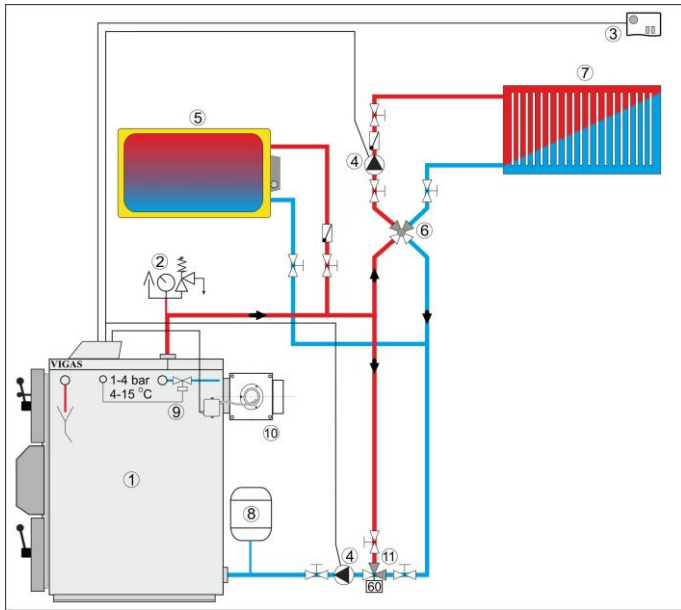

1. Boiler VIGAS
2. Safety elements
3. Room thermostat
4. Pump
5. Domestic water tank
6. 4-way valve
7. Heating circuit
8. Expansion tank
9. Drain valve Honeywell TS 131 ¾"
10. Discharge fan
11. Thermostatic valve ESBE VTC 312, VTC 511
12. 3-way mixing valve
13. Accumulation tank
M - Servo-motor unit
T - Thermometer KTY
TE – External thermometer KTY
TP – Pump thermostat

16.4 Recommended basic schematics with AK 4000 control + Expander AK4000 Basic set.

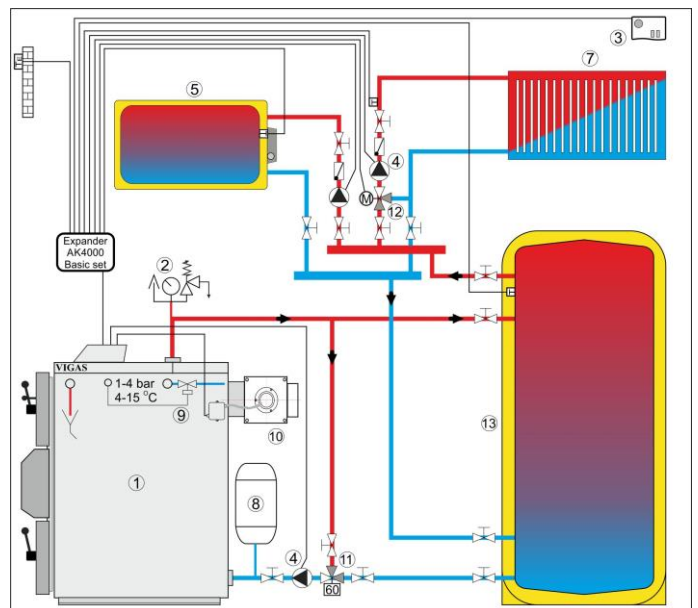
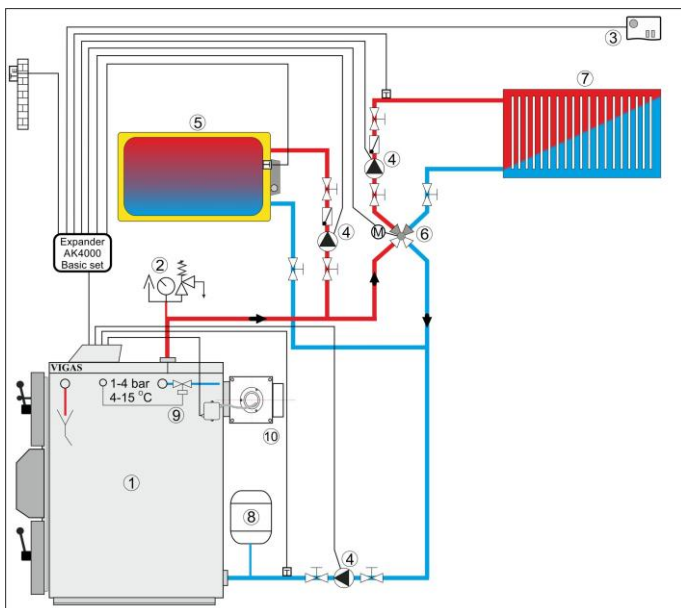

17. WIRING DIAGRAM CONNECTION

no.	Description	Code
1	AK 4000D Display	4001
2	AK 4000SL Lambda board	4003/A
3	Fan EBM 108-18DPA	0514
3a	Fan EBM 120-26DPA	0516
4	Capacitor	0515
4	STB fuse 100 °C	3029
5	Boiler sensor UNI type KTY	3026
6	Gas sensor type PT 1000	3027
7	Ultrasound receiver	4010
8	Ultrasound transmitter	4011
9	Motor sensor type KTY	1104
10	Container sensor type KTY	3032
11	Discharge fan V25 for 12,18 DPA	0507
12	Discharge fan V80 for 26 DPA	0508
12	Expander AK4000	0508
13	Memory modul AK4000M	SET
14	Room thermostat	4007
15	Ignition coil	3030/A
16	Motor + gear box TTM 203	0638
17	Pellet. EXPANDER AK4000EP	0640/A
18	Servouint Belimo 24V	4009
K1	Power cord EU	3008
K2	Fan cable	3025
K3	Cable set for STB fuse	3010
K4	Sensor connection modul	3015
K5	Main ground wire	3022/A
K5a	Ground wire for control panel	3018
K6	Communication wire AK4000D	3019
K7	Ignition coil cable	4006
K8	Cable motor + gear box	4014
K9	Power cable AK 4000EP	3013
K10	Communication cable AK4000	4012
K11	Cable for servouint Belimo	4015
		3013/A

● standard □ extra charge ★ VIGAS 26 DPA

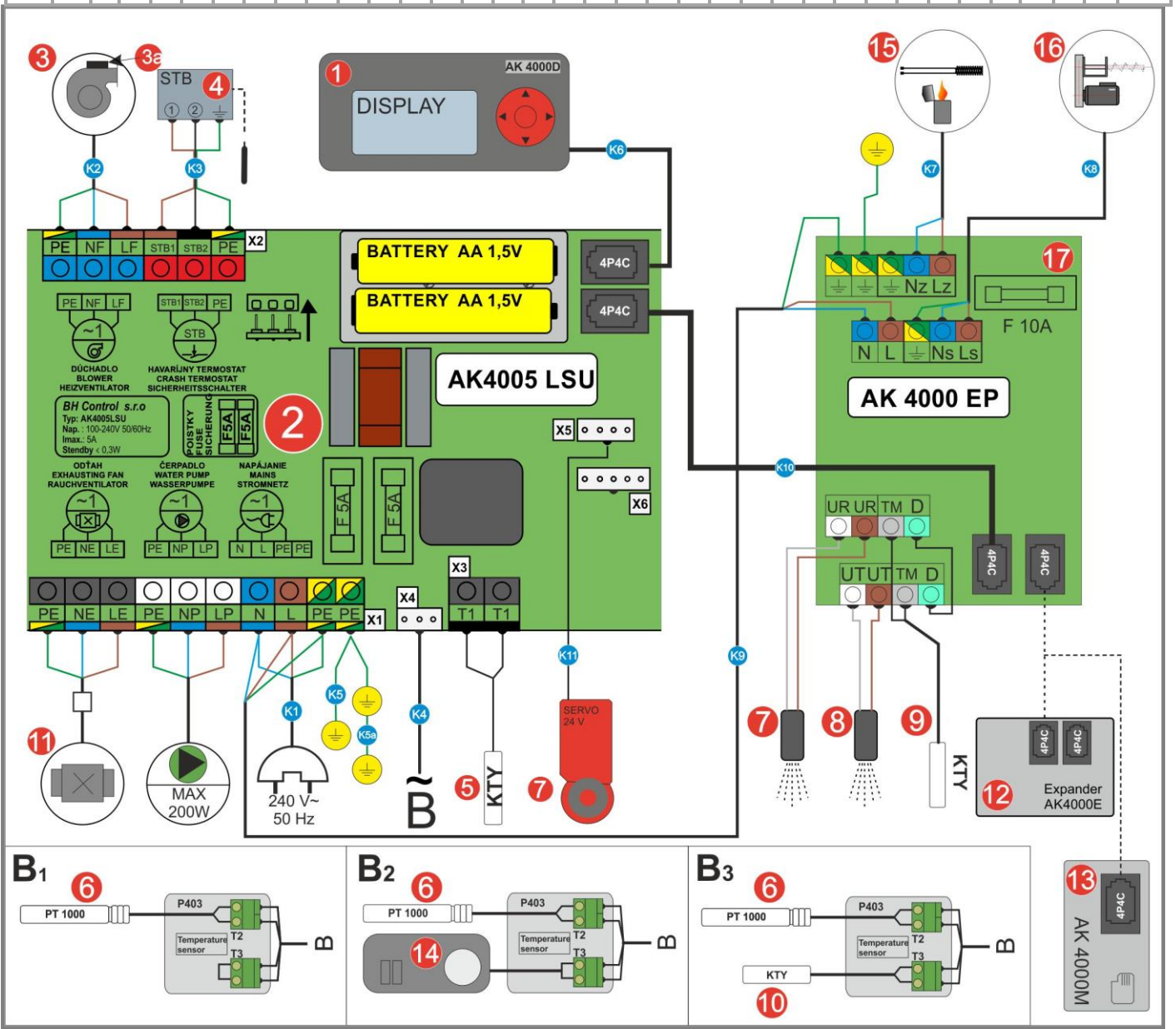

Records of electrical device connections (pump, discharge fan, room thermostat, expander, etc.)				
Date	Device	Service technician name	Certificate no.	Technician signature
Records of warranty and after warranty service				
Date	Service protocol number	Service technician name	Certificate number	Technician signature
Notes				

The list of most frequently used spare parts for VIGAS 18DPA (use „Code“ when ordering)			
Code		Code	
0102	Ceramic nozzle (3-hole) LAC pic.3/9	0101	Ceramic nozzle for VIGAS 12DPA
0104	Fire clay brick P4 (for iron ash) pic.3/12	0404	Heat exchanger seal for VIGAS 12DPA
3008	Servo Belimo 24V pic.3/39		
0401	Gasket / Door seal		
0405	Heat exchanger seal		
0514	Fan EBM 108 pic.3/7 for VIGAS 12,18 DPA		
0516	Fan EBM 120 pic.3/7 for VIGAS 26 DPA		
0601	Handle (complete)		
0633/A	Burner 12,18,26 DPA (refractory steel) pic.3/24		
0634/A	Tourniquet blades pic.3/33		
0636/C	Feeder device 12,18,26 DPA complete		
0637/A	Feeder device pic.3/32		
0638	Ignition coil pic.3/35		
0640/A	Motor + gearbox TTM 203 pic.3/34		
0641/A	Gear wheel (11z, 2x 32z)		
0660/B	Chain for pellet boiler short (40 cells)		
0660/C	Chain for pellet boiler long (42 cells)		
0677	Fric. bearings EFOM Ø16 container,tourniquet		

LETTER OF WARRANTY

Certificate of Quality and Completeness

Product

VIGAS **DPA** kW

Serial number :

Producer confirms, that boiler complies with standards, EN 303-5:2012, EN 61010-1+A2:2000, EN 50081-1:1995, EN 50082-1:2002, EN 61000-3-3:2000, EN 61000-3-2:2000+A1+A2:2001.

Date of production control

Stamp and signature of producer

Date of purchase

Date of commission

Stamp and signature of seller



VIGAS commission certificate

Product

VIGAS **DPA** kW

Serial number

Date of purchase

Date of commission

Stamp and signature of seller

Signature of authorized technician

User name and address :

Stamp and send to producer. !!

Instruction and warranty condition for customer:

- Claims regarding delivery completeness must be in accordance with Commercial law and Civil law of the supplier
- Damage and defects during transportation must be claimed by buyer to the carrier at the time of delivery.
- Warranty period is 24 months from the date of purchase.
- Warranty is valid only if the boiler is commissioned by an authorised technician.
- Warranty is valid only if the electric equipment is added according to regulation by authorized technician and recorded in relevant documents of connected devices.
- Warranty applies only to the boiler construction, used material and complete boiler unit.

Warranty does not apply:

- Consumer material: gasket, exchanger seal, under fan seal, ceramic nozzle, heatproof lining and fire clay bricks.
- Defects caused by customer.
- Defects caused by incorrect assembly, improper operation or maintenance, or if the boiler is used for any other purpose as specified by producer.
- Otherwise to claim guarantee applies by relevant provision of Civil law.

Producer reserves the right to make changes under the product innovation.

**Following operations were performed during commissioning:**

- Thorough explanation of the boiler maintenance and service.
- Boiler check before heating.
- Provided burning test.
- Complete and confirm data of warranty certificate.

.....
Boiler user signature

Stamp and send to producer !!

Information sheet with data on the energy consumption of products
VIGAS 12 DPA, 0032/104/2015

VIGAS 18 DPA, 0032/104/2015

VIGAS 26 DPA, 0063/104/2016

Commission Regulation (EU) 2015/1189, implementing Directive 2009/125/EC of the European Parliament and of the Council with regard to ecodesign requirements for solid fuel boilers, commission Regulation (EU) 2015/1189 supplementing Directive 2010/30/EU of the European Parliament and of the Council with regard to energy labelling of solid fuel boilers.

Product information	Symbol	Unit	VIGAS 12 DPA	VIGAS 18 DPA	VIGAS 26 DPA
Energy efficiency class			A++	A++	A++
Coefficient of energy	EEI		126	127	130
Seasonal Energy efficiency heating area	η_s	%	87	87	89
Mode skoting			Automatic		
Boiler is recommended to operated from a reservoir least		L	500		800
Condensing boiler			NO	NO	NO
Combined boiler			NO	NO	NO
Preffered fuel			Laminated wood in the form of pellets		
Characteristic when operating with preffered fuel					
Useful thermal output at rated power	P_n	kW	12,0	18,0	26
Useful efficiency at rated power	η_n	%	90,54	91,87	92,83
Useful thermal output at minimum output / <50%	P_p	kW	3,9	4,4	6,6
Useful efficiency at minimum output	η_n	%	89,56	90,39	91,74
Own electricity consumption at rated power	e_{lmax}	kW	0,085	0,085	0,130
Own electricity at minimum output	e_{lmin}	kW	0,014	0,014	0,010
Own electricity consumption in standby mode	P_{SB}	kW	0,001	0,001	0,001
Own electricity consupcion in firing mode	P_{zap}	kW	1,773	1,773	1,693
Sezone emissions heating area $T\check{C}^1$	PM	mg/m ³	24,0	13,2	21,0
Sezone emissions heating area POZ ¹	OGC	mg/m ³	17,5	14,4	19,7
Sezone emissions heating area CO ¹	CO	mg/m ³	421,3	260,9	360,5
Sezone emissions heating area NOx ¹	NOx	mg/m ³	149,6	156,1	139,3
Characteristic when operating with substitute fuel					
Substitute fuel			Chopped wood ,moisture content 20%		
Useful thermal output at rated power	P_n	kW	16,0	24,0	36,0
Useful efficiency at rated power	η_n	%	89,60	91,57	91,41
Useful thermal output at minimum output / <50%	P_p	kW	7,5	10,0	15,0
Useful efficiency at minimum output	η_n	%	88,19	90,95	90,10
Own electricity consumption at rated power	e_{lmax}	kW	0,014	0,030	0,038
Own electricity at minimum output	e_{lmin}	kW	0,003	0,005	0,012
Own electricity consumption in standby mode	P_{SB}	kW	0,001	0,001	0,001
Season emissions of the heating space $T\check{C}^2$	PM	mg/m ³	29,5	42,8	22,7
Season emissions of the heating space OGC ²	OGC	mg/m ³	26,3	28,3	28,2
Season emissions of the heating space CO ²	CO	mg/m ³	436,7	370,6	456,4
Season emissions of the heating space NOx ²	NOx	mg/m ³	185,7	221,6	150,0

1.Preffer fuel: Laminated wood in the form of pellets

2.Substitute fuel: Chopped wood, moisture content 20%



Serial number



Gasifying boilers

Producer:

Pavel Vigaš - VIMAR
M. Čulena 25
974 11 Banská Bystrica
SLOVAKIA

Production plant:

Pavel Vigaš - VIMAR
Príboj 796
976 13 Slovenská Ľupča
SLOVAKIA
tel.: 00421 48 4187 022
fax: 00421 48 4187 159

WWW.VIMAR.SK WWW.VIGAS.EU

vimar@vimar.sk

