



AE090JXEDEH  
AE120JXEDEH  
AE140JXEDEH  
AE160JXEDEH  
AE090JXEDGH  
AE120JXEDGH  
AE140JXEDGH  
AE160JXEDGH

# Air to Water Heat Pump Outdoor Unit installation manual

imagine the possibilities

Thank you for purchasing this Samsung product.

# Contents

---

## PREPARATION

Safety precautions .....	3
Product specifications .....	5

## INSTALLATION

Outdoor unit specification .....	6
Main components .....	7
Installing the unit .....	8
Electrical connections .....	16
Connecting the cable .....	17
Refrigerant piping work .....	25
Checking correct grounding .....	36
Setting the option switch and function of the keys .....	36
Pump down procedure .....	40
Completing the installation .....	42
Final checks and trial operation .....	43

## OTHERS

Trouble shooting .....	44
Error codes .....	44
COMMISSION REGULATION (EU) No 813/2013 <sup>1)</sup> .....	46
COMMISSION DELEGATED REGULATION (EU) No 811/2013 <sup>2)</sup> .....	66



### **Correct Disposal of This Product (Waste Electrical & Electronic Equipment)**

#### ***(Applicable in countries with separate collection systems)***

This marking on the product, accessories or literature indicates that the product and its electronic accessories (e.g. charger, headset, USB cable) should not be disposed of with other household waste at the end of their working life. To prevent possible harm to the environment or human health from uncontrolled waste disposal, please separate these items from other types of waste and recycle them responsibly to promote the sustainable reuse of material resources.

Household users should contact either the retailer where they purchased this product, or their local government office, for details of where and how they can take these items for environmentally safe recycling.

Business users should contact their supplier and check the terms and conditions of the purchase contract. This product and its electronic accessories should not be mixed with other commercial wastes for disposal.

# Safety precautions

Carefully follow the precautions listed as below because they are essential to guarantee the safety of SAMSUNG product.



## WARNING

- Always disconnect a power supply of Air-Water Heat Pump before servicing it or accessing components inside the unit.
- Verify that installation and testing operations shall be performed by qualified personnel.
- To prevent serious damage on the system and injuries to users, precautions and other notices shall be observed.

## Warning

- f Carefully read the content of this manual before installing the air to water heat pump and store the manual in a safe place in order to be able to use it as reference after installation.
- f For maximum safety, installers should always carefully read the following warnings.
- f Store the operation and installation manual in a safe location and remember to hand it over to the new owner if the Air to Water Heat pump is sold or transferred.
- f Store the user and installation manual in a safe location and remember to hand it over to the new owner if the air to water heat pump is sold or transferred.
- f This manual explains how to install Air-Water Heat Pump. The use of other types of units with different control systems may damage the units and invalidate the warranty. The manufacturer shall not be responsible for damages arising from the use of non compliant units.
- f The manufacturer shall not be responsible for damage originating from unauthorized changes or the improper connection of electric and hydraulic lines. Failure to comply with these instructions or to comply with the requirements set forth in the "Operating limits" table, included in the manual, shall immediately invalidate the warranty.
- f Failure to comply with these instructions or to comply with the requirement on the Operating Range (Heat : -25~35 °C/ Cool: 10~46 °C) set forth in the Product Specification (p.6) shall immediately invalidate the warranty.
- f Do not use the units if you see some damages on the units and recognize something bad such as loud noisy, smell of burning.
- f In order to prevent electric shocks, fires or injuries, always stop the unit, disable the protection switch and contact SAMSUNG's technical support if the unit produces smoke, if the power cable is hot or damaged or if the unit is very noisy.
- f Always remember to inspect the unit, electric connections, refrigerant tubes and protections regularly. These operations shall be performed by qualified personnel only.
- f The unit contains moving parts and electrical parts, which should always be kept out of the reach of children.
- f Do not attempt to repair, move, alter or reinstall the unit by unauthorized personnel, these operations may cause product damage, electric shocks and fires.
- f Do not place containers with liquids or other objects on the unit.
- f All the materials used for the manufacture and packaging of the air to water heat pump are recyclable.
- f The packing material and exhaust batteries of the remote controller(optional) must be disposed of in accordance with local regulations.
- f The air to water heat pump contains a refrigerant that has to be disposed of as special waste. At the end of its life cycle, the heat pump must be disposed of in authorized centers or returned to the retailer so that it can be disposed of correctly and safely.
- f Wear protective gloves to unpack, move, install, and service the unit to avoid your hands being injured by the edge of the parts.
- f Do not touch the internal parts (water pipes, refrigerant pipes, heat exchangers, etc) while running the units. And if you need to adjust and touch the units, have enough time for the unit can be cooled and be sure to wear protective gloves.
- f In case of refrigerant leakage, try to avoid getting in contact with the refrigerant because this could result in severe wounds.



# Safety precautions

---

- ⓘ f When you install the Air to water heat pump in a small room, you must consider a proper ventilation to prevent a leakage level within the maximum permissible limit.
  - In that case, you may die from suffocation by some possibility.
- ⓘ f Make sure to safely dispose of packing materials. Packing materials, such as nails and other metal or wooden pallets may cause children get injured.
- ⓘ f Inspect the product shipped and check if damaged during transport. If the product has some damages, DO NOT INSTALL and immediately discuss about the damages with the carrier or retailer (if the installer or the authorized technician has collected the material from the retailer.)
- ⓘ f Our units shall be installed in compliance with the spaces described in the installation manual, to ensure accessibility from both sides and allow repairs or maintenance operations to be carried out. If the units installed without complying with procedures described in manual, additional expenses can be asked because special harnesses, ladders, scaffolding or any other elevation system for repair service will NOT be considered part of the warranty and will be charged to the end customer.
- ⓘ f Always make sure that the power supply is compliant with local safety standards.
- ⓘ f Verify that the voltage and frequency of the power supply comply with the specifications and input power is sufficient to ensure the operation of any other domestic appliance connected to the same electric lines. Always verify that the cut-off and protection switches are suitably selected.
- ⓘ f Always verify that electric connections (cable entry, section of leads, protections. . .) are compliant with the electric specifications and with the instructions provided in the wiring scheme. Always verify that all connections comply with the standards applicable to the installation of air to water heat pumps. Devices disconnected from the power supply should be completely disconnected in the condition of overvoltage category.
- ⓘ f Do not connect the earth wire to the gas pipe or water pipe, lighting rod, surge absorber, or telephone earth wire. If earthing is not complete, it may cause an electric shock or fire.
- ⓘ f Be sure to install both an earth leakage detector and circuit breaker with specified capacity in accordance with relevant local and national regulations.
  - If it is not installed properly, it may cause electric shocks and fire.
- ⓘ f Make sure that the condensed water runs well out of the unit at low ambient temperature. Drain pipe and cond heater can frost/ice can not grow. If drain work is not effective for releasing condensed water, it can make the units get damaged by massive ice and system can be stop , covered by ice.
- ⓘ f Install the power cable and communication cable of the indoor and outdoor unit at least 1 m away from the electric appliance.
- ⓘ f Protect the unit from rats or small animals. If an animal makes a contact with the electric parts, it can cause malfunctions, smoke or fire. Please instruct the customer to keep the area around the unit clean.
- ⓘ f Do not disassemble and alter the heater at your own discretion.
- ⓘ f This appliance is not intended for use by persons (including children) with reduced physical, sensory or mental capabilities, or lack of experience and knowledge, unless they have been given supervision or instruction concerning use of the appliance by a person responsible for their safety. Children should be supervised to ensure that they do not play with the appliance.
- ⓘ f **For use in Europe** : This appliance can be used by children aged from 8 years and above and persons with reduced physical, sensory or mental capabilities or lack of experience and knowledge if they have been given supervision or instruction concerning use of the appliance in a safe way and understand the hazards involved. Children shall not play with the appliance. Cleaning and user maintenance shall not be made by children without supervision.
- ⓘ f Be sure not to perform power cable modification, extension wiring, and multiple wire connection.
  - It may cause electric shock or fire due to poor connection, poor insulation, or current limit override.
  - When extension wiring is required due to power line damage, refer to "How to connect your extended power cables" in the installation manual.





# Product specifications

## Product line-up

Line-up				Remark
Heat pump units	Chassis			
	Model name	AE090JXEDEH AE090JXEDGH	AE120JXEDEH AE140JXEDEH AE160JXEDEH AE120JXEDGH AE140JXEDGH AE160JXEDGH	

## Accessories

- ☐ f Keep supplied accessories until the installation is finished.
- ☐ f Hand the installation manual over to the customer after finishing installation.
- ☐ f The quantities are indicated in parentheses.
- ☐ f The base heater inside outdoor unit works in accordance with the weather of outdoor.

Installation manual (1)	Drain plug (1)	Rubber Leg(4)	Drain cap (3)
			

# Outdoor unit specification

Type	Unit	AE090JXEDEH	AE120JXEDEH	AE140JXEDEH	AE160JXEDEH
Power source	-	1P, 220~240 VAC 50 Hz	1P, 220~240 VAC 50 Hz		
Weight (net/gross)	kg	68.0/78.0	100.0/109.5		
Size (WxHxD, net)	mm	940 x 998 x 330	940 x 1,420 x 330		
Noise (Heat/Cool, Pressure)	dB(A)	49/50	50/50	50/52	52/54
Operating Range (Heat/Cool)	°C	-25~35/10~46	-25~35/10~46		

Type	Unit	AE090JXEDGH	AE120JXEDGH	AE140JXEDGH	AE160JXEDGH
Power source	-	3P, 380~415 VAC 50 Hz	3P, 380~415 VAC 50 Hz		
Weight (net/gross)	kg	76.0/84.5	101.5/111.0		
Size (WxHxD, net)	mm	940 x 998 x 330	940 x 1,420 x 330		
Noise (Heat/Cool, Pressure)	dB(A)	49/50	50/50	50/52	52/54
Operating Range (Heat/Cool)	°C	-25~35/10~46	-25~35/10~46		

\*  At the temperature -25 °C ~ -20 °C, operation is available but capacity cannot be guaranteed.

# Main components

## Dimensions(Overall)

Heat pump for R-410A.

### 1-Fan chassis

□ f AE090JXEDEH, AE090JXEDGH

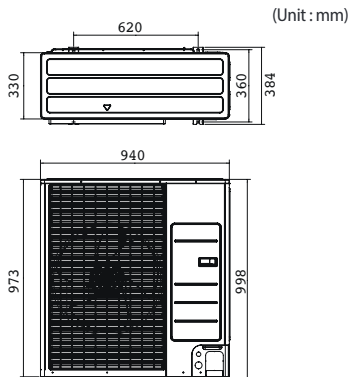
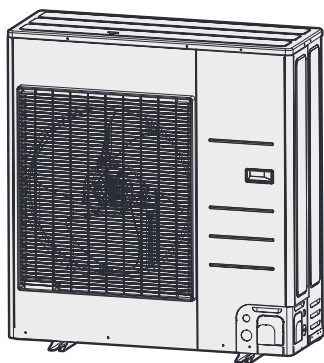

### 2-Fan chassis

□ f AE120/140/160JXEDEH, AE120/140/160JXEDGH

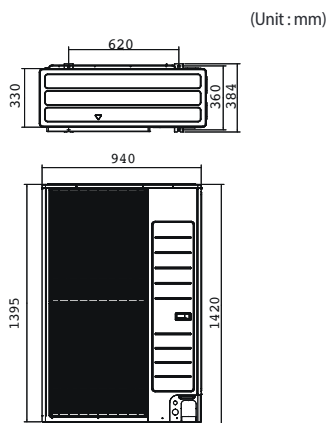

# Installing the unit

## Deciding on where to install the outdoor unit

Decide the installation location regarding the following condition and obtain the user's approval.

- ❗ f The outdoor unit must not be placed on its side or upside down, as the compressor lubrication oil will run into the cooling circuit and seriously damage the unit.
- ❗ f Choose a location that is dry and sunny, but not exposed to direct sunlight or strong winds.
- ❗ f Do not block any passageways or thoroughfares.
- ❗ f Choose a location where the noise of the Air to Water Heat Pump when running and the discharged air do not disturb any neighbours.
- ❗ f Choose a position that enables the pipes and cables to be easily connected to the other hydraulic system.
- ❗ f Install the outdoor unit on a flat, stable surface that can support its weight and does not generate any unnecessary noise and vibration.
- ❗ f Position the outdoor unit so that the air flow directly stream towards the open area.
- ❗ f Place the outdoor unit where there are no plants and animals because they may cause malfunction of outdoor unit.
- ❗ f Maintain sufficient clearance around the outdoor unit, especially from a radio, computer, stereo system, etc.
- ❗ f When installing the outdoor unit near seashore, make sure it is not directly exposed to sea breeze. If you can not find an adequate place without direct sea breeze, make sure to apply anti-corrosion coating on the heat exchanger.

- ❗ f Install the outdoor unit in a place (such as near buildings etc.) where it can be prevented from sea breeze which can damage the outdoor unit.

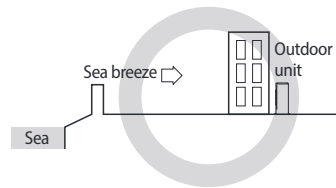
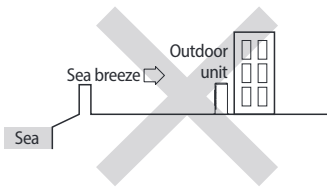

- ❗ f If you cannot avoid installing the outdoor unit by the seashore, construct a protection wall around to block the sea breeze.

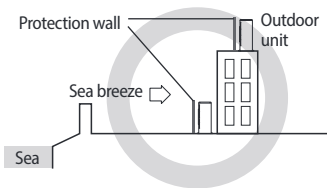

- Protection wall should be constructed with a solid material such as concrete to block the sea breeze and the height and the width of the wall should be 1.5 times larger than the size of the outdoor unit. Also, secure over 700 mm between the protection wall and the outdoor unit for exhausted air to ventilate.

- ❗ f Install the outdoor unit in a place where water can drain smoothly.

- \* ❗ If you cannot find a place satisfying above conditions, please contact manufacturer. Make sure to clean the sea water and the dust on the outdoor unit heat exchanger and spread corrosion inhibitor on heat exchanger. (At least one time per one year.)



- Depending on the condition of power supply, unstable power or voltage may cause malfunction of the parts or control system. (At the ship or places using power supply from electric generator, etc.)



- ❗ Do not install the Air to Water Heat Pump in following places.
  - The place where there is mineral oil or arsenic acid. There is a chance that parts may get damaged due to burned resin. The capacity of the heat exchanger may reduce or the Air to Water Heat pump may be out of order.
  - The place where corrosive gas such as sulfurous acid gas generates from the vent pipe or air outlet. The copper pipe or connection pipe may corrode and refrigerant may leak.
  - The place where there is a danger of existing combustible gas, carbon fiber or flammable dust. The place where thinner or gasoline is handled.



- ❗ This device must be installed according to the national electrical rules.
- ❗ With an outdoor unit having net weight upper than 60 kg, we suggest do not install it suspended on wall, but considering floor standing one.

- ❗ If the outdoor unit is installed at a height, ensure that its base is firmly fixed in position.
- ❗ Make sure that the water dripping from the drain hose runs away correctly and safely.
- ❗ When you install the outdoor unit at wayside, you should install it above 2 m height or make sure that the heat from the outdoor unit shouldn't be in direct contact with passersby. (The ground for application :The revision of regulation for facility in building by the law of the Ministry of Construction and Transportation.

### Moving the Outdoor Unit by Wire Rope

Fasten the outdoor unit by two 8 m or longer wire ropes as shown at the figure. To prevent from damage or scratches, insert a piece of cloth between the outdoor unit and rope, then move the unit.

- \* The appearance of the unit may be different from the picture depending on the model.

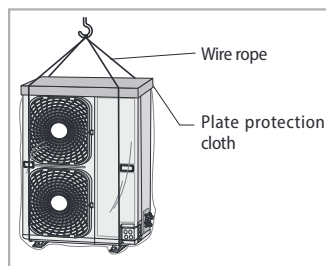

# Installing the unit

## Space requirements for outdoor unit

### When installing 1 outdoor unit

(Unit : mm)

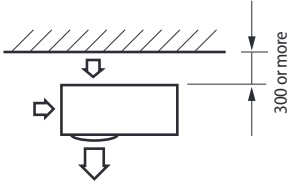

\* When the air outlet is opposite the wall

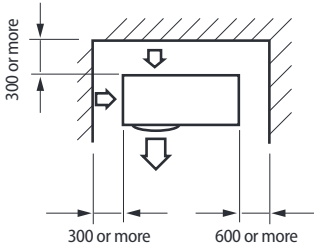

\* When 3 sides of the outdoor unit are blocked by the wall

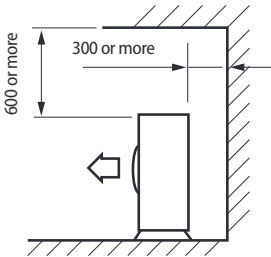

\* The upper part of the outdoor unit and the air outlet is opposite the wall

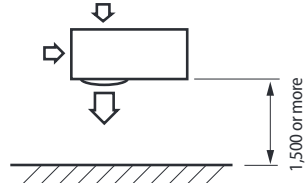

\* When the air outlet is towards the wall

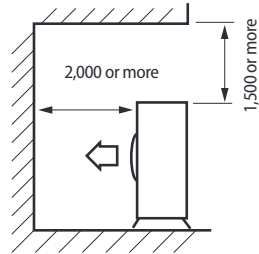

\* The upper part of the outdoor unit and the air outlet is towards the wall

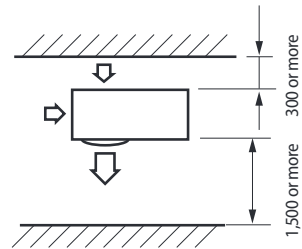

\* When front and rear side of the outdoor unit is towards the wall

## When installing more than 1 outdoor unit

(Unit : mm)

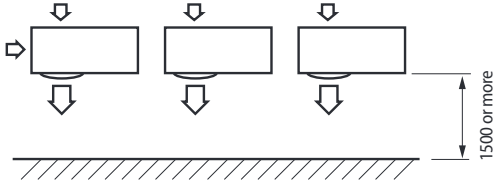

\* When the air outlet is towards the wall

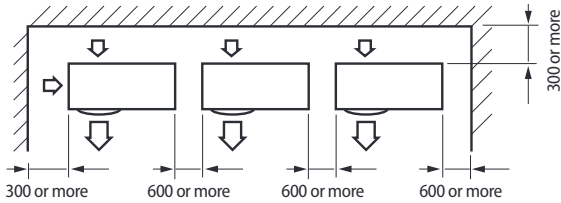

\* When 3 sides of the outdoor unit are blocked by the wall

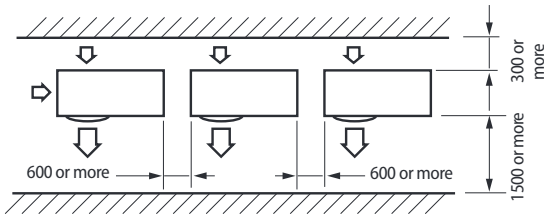

\* When front and rear side of the outdoor unit is towards the wall

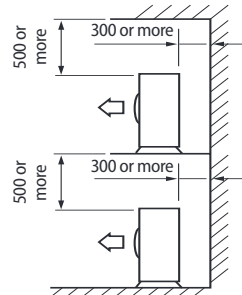

\* The upper part of the outdoor unit and the air outlet is opposite the wall

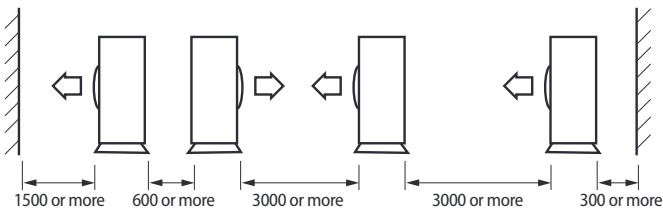

\* When front and rear side of the outdoor unit is towards the wall



The units must be installed according to distances declared, in order to permit accessibility from each side, either to guarantee correct operation of maintenance or repairing products. The unit's parts must be reachable and removable completely under safety condition (for people or things).

# Installing the unit

## Outdoor unit installation

The outdoor unit must be installed on a rigid and stable base to avoid any increase in the noise level and vibration, particularly if the outdoor unit is to be installed in a location exposed to strong winds or at a height, the unit must be fixed to an appropriate support (wall or ground).

☞ f Fix the outdoor unit with anchor bolts.



☞ The anchor bolt must be 20 mm or higher from the base surface.



☞ When tightening the anchor bolt, tighten the rubber washer to prevent the outdoor unit bolt connection part from corroding.

☞ Make a drain outlet around the base for outdoor unit drainage.

☞ If the outdoor unit is installed on the roof, you have to check the ceiling strength and waterproof the unit.

(Unit : mm)

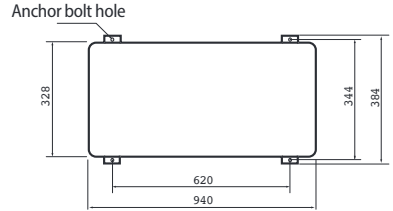

## Outdoor unit support

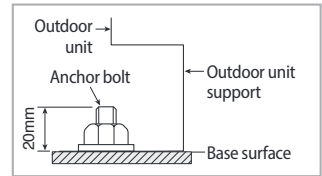
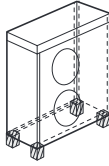
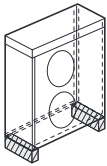

### OUTDOOR UNIT INSTALLED ON THE WALL BY RACK

☞ f Ensure the wall will be able to suspend the weight of rack and outdoor unit ;

☞ f Install the rack close to the column as much as possible ;

☞ f Install proper grommet in order to reduce noise and residual vibration transferred by outdoor unit towards wall.



### When installing air guide duct

☞ Check and make sure that screws do not damage the copper pipe.

☞ Secure air guide duct on guard fan.

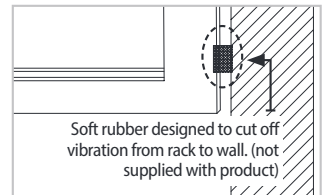
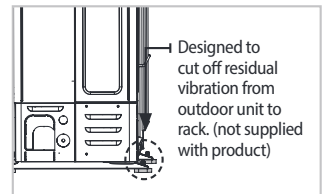

## Drain work

### General area

While Air-Water Heat Pump is running in heating mode, Ice can begin accumulate on the surface of condenser. To prevent Ice from growing, system go into De-frost mode and then Ice on the surface changes to water.

Dropped water from condenser shall be eliminated through running drain holes to prevent Ice growing at low temperature.

If in case there is not enough space for drainage out of the unit, additional drain works are required. Follow the description as below

- Make space more than 100mm between the bottom of the outdoor unit and the ground for installation of the drain hose.
- Insert the drain plug into the hole on the bottom of the outdoor unit.
- Connect the drain hose to the drain plug.
- Make sure dusts or small branches should not go into the drain hose.

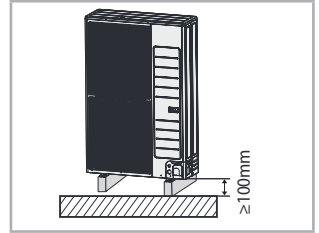

If drain work is not enough, it can lead to system performance degradation and system damages.

### Drain hole $\Phi 20 \times 4$ ea

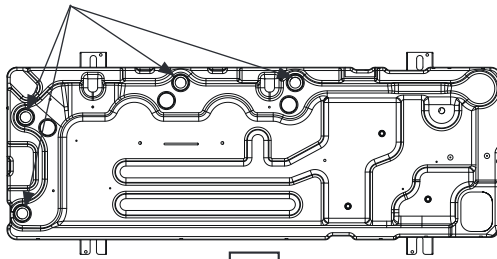

Air discharge side

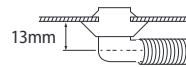

1. Prepare a water drainage channel around the foundation, to drain waste water from around the unit.
2. If the water drainage of the unit is not easy, please build up the unit on a foundation of concrete blocks, etc. (the height of the foundation should be maximum 150 mm).
3. If you install the unit on a frame, please install a waterproof plate within 150 mm of the underside of the unit in order to prevent the invasion of water from the lower direction.
4. When installing the unit in a place frequently exposed to snow, pay special attention to elevate the foundation as high as possible.
5. If you install the unit on a building frame, please install a waterproof plate (field supply) (within 150mm of the underside of the unit) in order to avoid the drain water dripping. (See figure)

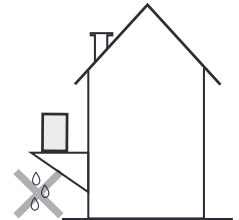

# Installing the unit

## • Heavy snow fall area (Natural drainage)

ⓘ f When using the air conditioner in the heating mode, ice may accumulate. During de-icing (defrost operation), the condensed water must be drained off safely. For the air conditioner operates well, you must follow the instructions below.

- Make space more than 80mm between the bottom of the outdoor unit and the ground for installation.

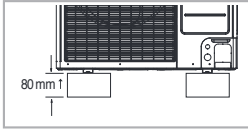

- If the product is installed in a region of heavy snow, allow enough separation distance between the product and the ground.
- When installing the product, make sure that the rack is not placed under the drain hole.
- Ensure that the drained water runs off correctly and safely.



CAUTION

- In areas with heavy snow fall, piled snow could block the air intake. To avoid this incident, install a frame that is higher than estimated snow fall. In addition, install a snow-proof hood to avoid snow from piling on the outdoor unit.
- If ice accumulates on the base, it may cause critical damage to the product. (e.g., a lakeside in a cold area, the seashore, an alpine region, etc.)
- In a heavy snowfall area, do not install the drain plug and drain cap into the outdoor unit. And, it may cause frozen ground. Therefore, take appropriate measures to prevent it.

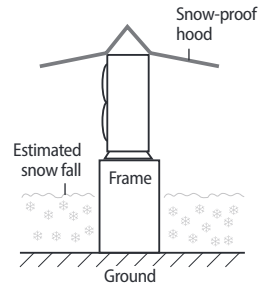

## Selecting a location in cold climates



When operating the unit in a low outdoor ambient temperature, be sure to follow the instructions described below.

- ❑ f To prevent exposure to wind, install the unit with its suction side facing the wall.
- ❑ f Never install the unit at a site where the suction side may be exposed directly to wind.
- ❑ f To prevent exposure to wind, install a baffle plate on the air discharge side of the unit.
- ❑ f In heavy snowfall areas it is very important to select an installation site where the snow will not affect the unit. If lateral snowfall is possible, make sure that the heat exchanger coil is not affected by the snow (If necessary construct a lateral canopy)

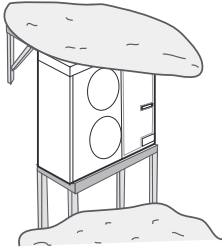

1. Construct a large canopy.
2. Construct a pedestal.
  - Install the unit high enough off the ground to prevent it being buried under snow.

- ❑ f The fan inside outdoor unit will operate regularly, as designed, with switch "K6 ON" to prevent from snow accumulating inside outdoor unit. (Refer to page 36)
- ❑ f The outdoor unit should be installed with consideration of the direction of strong winds. These can make the unit turn over, so the side of the unit should be set to face the wind, not the front of the unit.

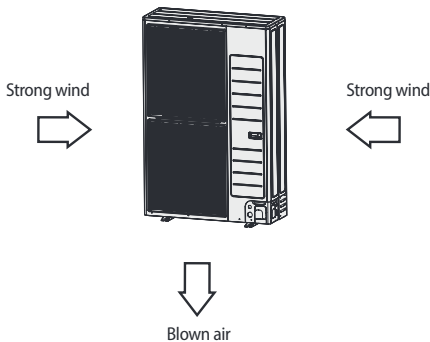

# Electrical connections

## Overall system configuration

### Connection of the power cable (1 phase 2 wires)

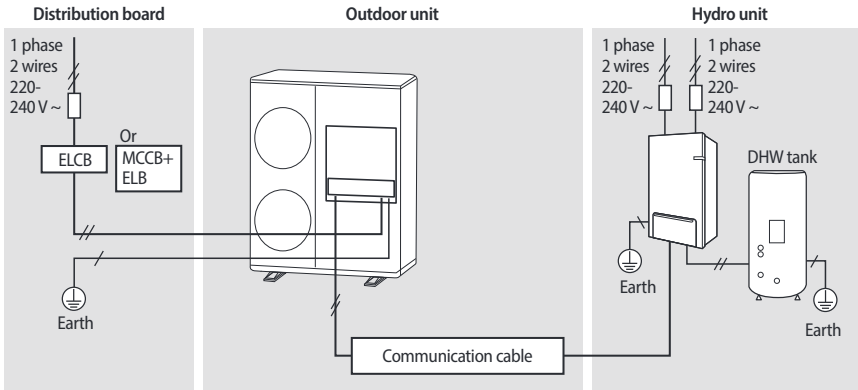

- Install cabinet panel near the outdoor unit for the convenience of service and emergency operation off.
- Make sure to install the circuit breaker with the over-current and electric leakage protection.

### Connection of the power cable (3 phase 4 wires)

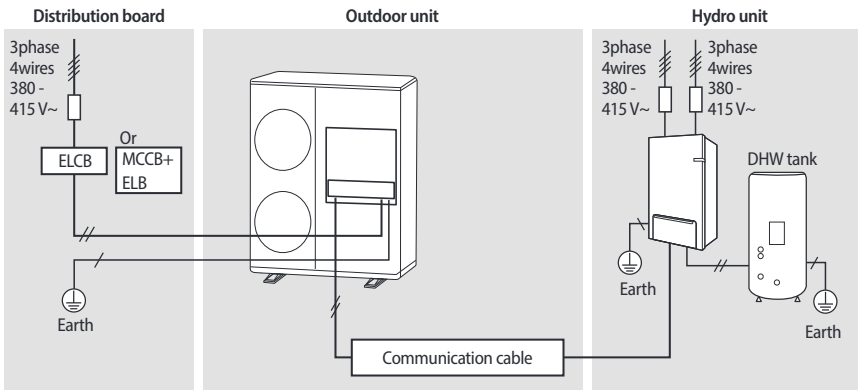

- Install cabinet panel near the outdoor unit for the convenience of service and emergency operation off.
- Make sure to install the circuit breaker with the over-current and electric leakage protection.



# Connecting the cable

## Power cable specifications

### 1 phase

Outdoor unit	Rated		Voltage Range		MCA	MFA
	Hz	Volts	Min	Max	Min. Circuit Amps.	Max. Fuse Amps.
AE090JXEDEH	50	220-240	198	264	22 A	27.5 A
AE120JXEDEH	50	220-240	198	264	28 A	35 A
AE140JXEDEH	50	220-240	198	264	30 A	37.5 A
AE160JXEDEH	50	220-240	198	264	32 A	40 A

ⓘ f The power cable is not supplied with Air to Water Heat pump.

ⓘ f Supply cords of parts of appliances for outdoor use shall not be lighter than polychloroprene sheathed flexible cord (Code designation IEC:60245 IEC 57 / CENELEC:H05RN-F)

ⓘ f This Equipment complies with IEC 61000-3-12.

### 3 Phase

Outdoor unit	Rated		Voltage Range		MCA	MFA
	Hz	Volts	Min	Max	Min. Circuit Amps.	Max. Fuse Amps.
AE090JXEDGH	50	380-415	342	457	10 A	16.1 A
AE120JXEDGH	50	380-415	342	457	10 A	16.1 A
AE140JXEDGH	50	380-415	342	457	11 A	16.1 A
AE160JXEDGH	50	380-415	342	457	12 A	16.1 A

ⓘ f The power cable is not supplied with Air to Water Heat pump.

ⓘ f Supply cords of parts of appliances for outdoor use shall not be lighter than polychloroprene sheathed flexible cord (Code designation IEC:60245 IEC 66 / CENELEC:H07RN-F)

ⓘ f This equipment complies with IEC 61000-3-12 provided that the short-circuit power  $S_{sc}$  is greater than or equal to 3.3[MVA] at the interface point between the user's supply and the public system. It is the responsibility of the installer or user of the equipment to ensure, by consultation with distribution network operator if necessary, that the equipment is connected only to a supply with a short-circuit power  $S_{sc}$  greater than or equal to 3.3[MVA].

# Connecting the cable

## Specification of connection cables (common in use)

Power supply	Max/Min(V)	Communication cable
1Φ, 220-240 V, 50 Hz	±10 %	0.75~1.5 mm <sup>2</sup> , 2 wires
3Φ, 380-415 V, 50 Hz		

For Power Cable, use the grade H07RN-F or H05RN-F materials.

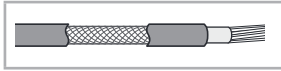

When installing the indoor unit, outdoor unit use the double shielded (Tape aluminum / polyester braid + copper) cable of FROHH2R type.

## 1-phase terminal block spec

AC power : M5 screw

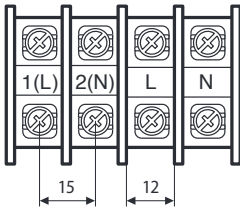

Communication : M4 screw

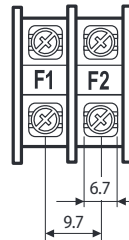

## 3-phase terminal block spec

AC power : M4 screw

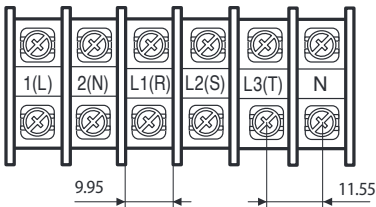

Communication : M4 screw

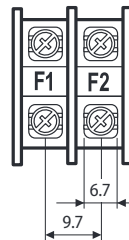

## Wiring diagram of power cable

### When using ELB for 1 phase and 3 phase

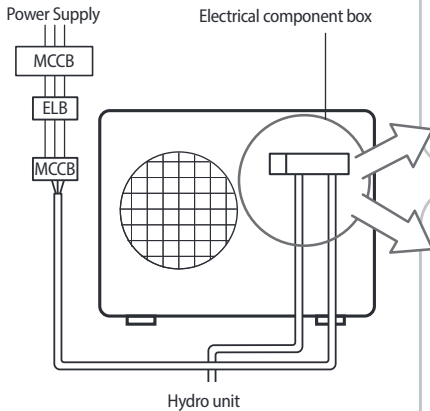

\* The appearance of the unit may be different from the picture depending on the model.

f 1 phase

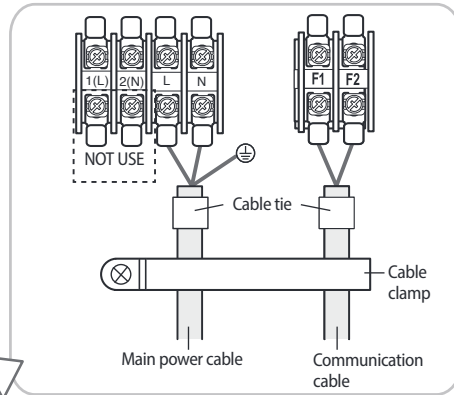

f 3 phase

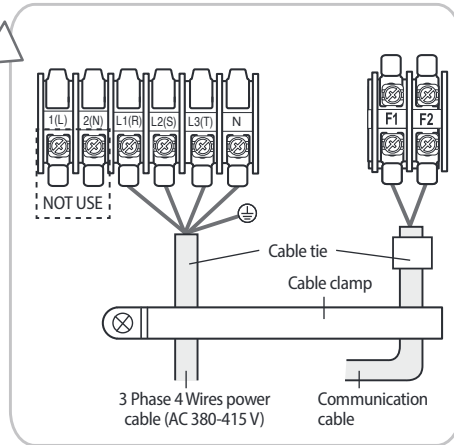

- You should connect the power cable into the power cable terminal and fasten it with a clamp.
- The unbalanced power must be maintained within 2% of supply rating.
  - If the power is unbalanced greatly, it may shorten the life of the condenser. If the unbalanced power is exceeded over 4% of supply rating, the indoor unit is protected, stopped and the error mode indicates.
- To protect the product from water and possible shock, you should keep the power cable and the connection cord of the indoor and outdoor units within ducts. (with appropriate IP rating and material selection for your application)
- Ensure that main supply connection is made through a switch that disconnects all poles, with contact gap of at least 3 mm.
- Devices disconnected from the power supply should be completely disconnected in the condition of overvoltage category.
- Keep distances of 50 mm or more between power cable and communication cable.

# Connecting the cable

## 1 phase 2 wires

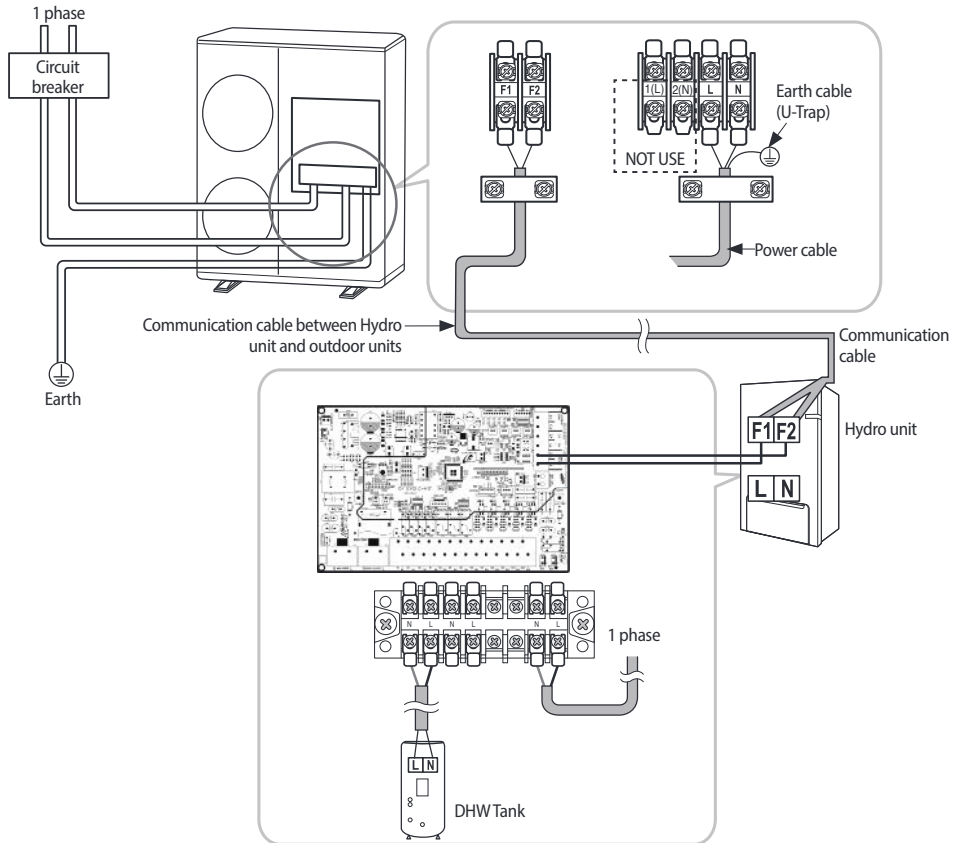

- When removing the outer cover of the power cable, use the appropriate tools to prevent damaging the inner cover.
- Make sure to place the outer cover of the power cable and the communication cable, at least 20 mm into the electrical parts.
- Communication wiring should be done separately from the power cable and other communication cables.

### 3 phase 4 wires

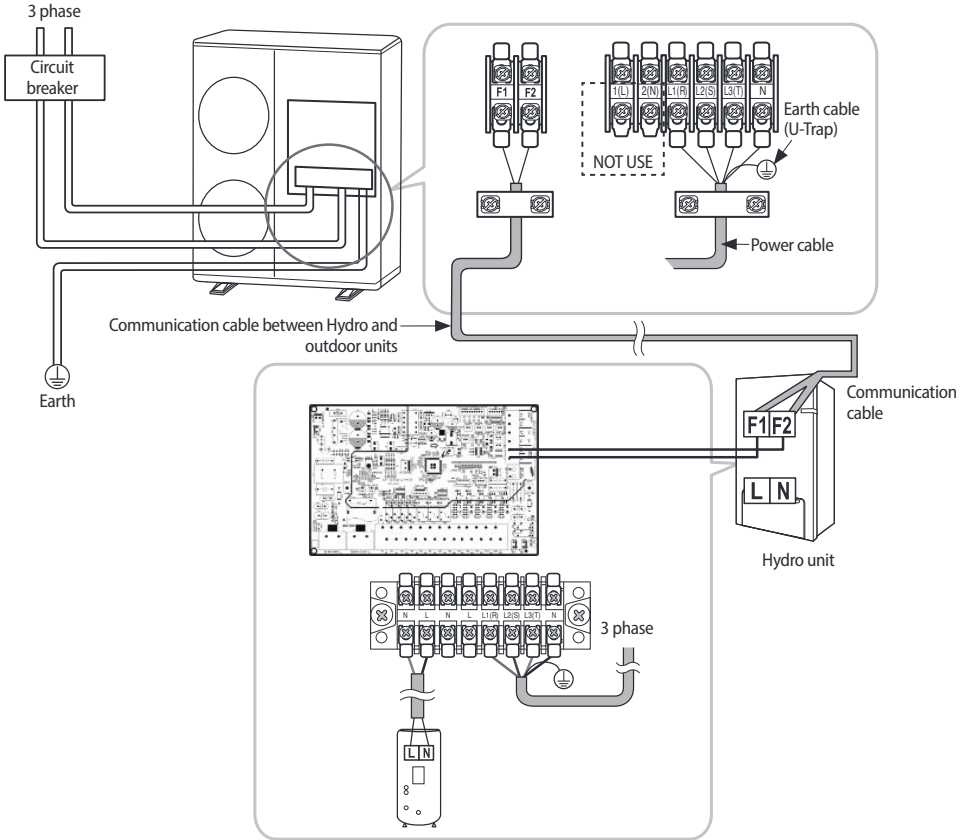

- When removing the outer cover of the power cable, use the appropriate tools to prevent damaging the inner cover.
- Make sure to place the outer cover of the power cable and the communication cable, at least 20 mm into the electrical parts.
- Communication wiring should be done separately from the power cable and other communication cables.

# Connecting the cable

## Connecting the power terminal

- ⓘ f Connect the cables to the terminal board using the compressed ring terminal.
- ⓘ f Connect the rated cables only.
- ⓘ f Connect using a wrench which is able to apply the rated torque to the screws.
- ⓘ f If the terminal is loose, fire may occur caused by arc. If the terminal is connected too firmly, the terminal may be damaged.

Tightening Torque (kgf.cm)	
M4	12~18
M5	20~30

## Installing the earth wire

- ⓘ f Earthing must be done by your installation specialist for your safety.
- ⓘ f Use the earth wire by referring to the specification of the electric cable for the outdoor unit.

## Earthing the power cable

- ⓘ f The standard of earthing may vary according to the rated voltage and installation place of the Air to Water Heat Pump.
- ⓘ f Earth the power cable according to the following.

Power condition \ Installation place	High humidity	Average humidity	Low humidity
	Electrical potential of lower than 150 V		Perform the earthing work 3. <sup>Note 1)</sup>
Electrical potential of higher than 150 V	Must perform the earthing work 3. <sup>Note 1)</sup> (In case of installing circuit breaker)		

### \* ⓘ Note 1) Earthing work 3

- Earthing must be done by your installation specialist.
- Check if the earthing resistance is lower than 100Ω. When installing a circuit breaker that can cut the electric circuit in case of a short circuit, the allowable earthing resistance can be 30~500Ω.

ⓘ f When using the terminal for earthing only

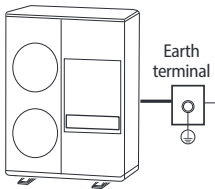



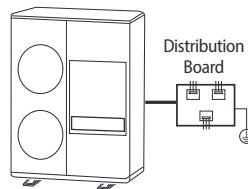

ⓘ f When using earthing of the switchboard



## How to connect your extended power cables

1. Prepare the following tools.

Tools	Crimping pliers	Connection sleeve (mm)	Insulation tape	Contraction tube (mm)
Spec	MH-14	20xØ6.5(HxOD)	Width 19mm	70xØ8.0(LxOD)
Shape				

2. As shown in the figure, peel off the shields from the rubber and wire of the power cable.

- Peel off 20 mm of cable shields from the pre-installed tube.

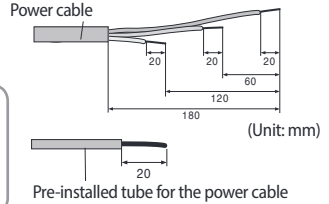

- For information about the power cable specifications for indoor and outdoor units, refer to the installation manual.
- After peeling off cable wires from the pre-installed tube, insert a contraction tube.

3. Insert both sides of core wire of the power cable into the connection sleeve.

### f Method 1

- Push the core wire into the sleeve from both sides.

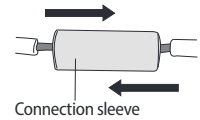

### f Method 2

- Twist the wire cores together and push it into the sleeve.

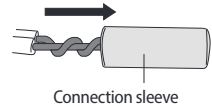

4. Using crimping tool, compress the two points and flip it over and compress another two points in the same location.

- The compression dimension should be 8.0.
- After compressing it, pull both sides of the wire to make sure it is firmly pressed.

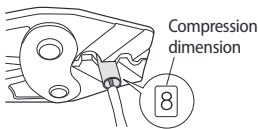

### f Method 1

Compress it 4 times.

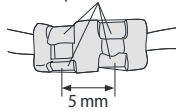

### f Method 2

Compress it 4 times.

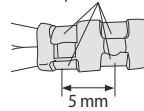

# Connecting the cable

5. Wrap it with the insulation tape twice or more and position your contraction tube in the middle of the insulation tape. Three or more layers of insulation are required.

f Method 1

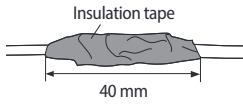

f Method 2

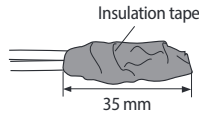

6. Apply heat to the contraction tube to contract it.



7. After tube contraction work is completed, wrap it with the insulation tape to finish.



- Make sure that the connection parts are not exposed to outside.
- Be sure to use insulation tape and a contraction tube made of approved reinforced insulating materials that have the same level of withstand voltage with the power cable. (Comply with the local regulations on extensions.)

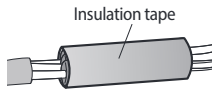

- In case of extending the electric wire, please DO NOT use a round-shaped Pressing socket.
- Incomplete wire connections can cause electric shock or a fire.

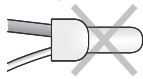



# Refrigerant piping work

- ☐ f Install the refrigerant pipe within the maximum allowable length, difference in height and length of after the first branch pipe.
- ☐ f The pressure of the R-410A is high.  
Use only rated refrigerant pipe and follow the installation method.
- ☐ f Use clean refrigerant pipe Where there is no harmful ion, oxide, dust, iron content or moisture.
- ☐ f Use adequate tools and accessories for R-410A.

<b>Manifold gauge</b>	☐ Use manifold gauge only for R-410A to prevent the inflow of foreign substances.
<b>Vacuum pump</b>	☐ Use vacuum pump with check valve to prevent pump oil from flowing backward while the vacuum pump is stopped. ☐ Use the vacuum pump that the vacuum induction is available up to 5Torr. (-100.7kPa)
<b>Flare nut</b>	☐ Use only flare nut supplied with the product.

## Allowable length of the refrigerant pipe and the installation examples

- ☐ f AE090JXEDEH, AE120JXEDEH, AE140JXEDEH, AE160JXEDEH, AE090JXEDGH, AE120JXEDGH, AE140JXEDGH, AE160JXEDGH

Outdoor unit

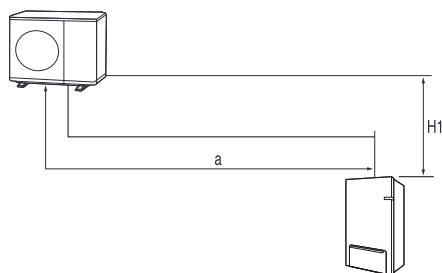

Item				Example	Remarks
Maximum allowable length of pipe	Outdoor unit ~ Hydro unit	Total length	Less than 50 m	$a \leq 50$ m	
Maximum allowable height	Outdoor unit ~ Hydro unit	Less than 30 m		H1	If outdoor unit is located lower position H1 $\leq 15$ m
Additional refrigerant calculation		R=Basic charge + additional charge by the piping length			

Contact the manufacturer if the length should exceed.

# Refrigerant piping work

## Selecting the refrigerant pipe

Outdoor unit capacity (kW)	Liquid side (mm)	Gas side (mm)
AE090JXEDEH	ø6.35	ø15.88
AE120JXEDEH	ø9.52	ø15.88
AE140JXEDEH	ø9.52	ø15.88
AE160JXEDEH	ø9.52	ø15.88
AE090JXEDGH	ø6.35	ø15.88
AE120JXEDGH	ø9.52	ø15.88
AE140JXEDGH	ø9.52	ø15.88
AE160JXEDGH	ø9.52	ø15.88

Outer diameter (mm)	Minimum thickness (mm)	Temper grade
ø 6.35	0.7	C1220T-O
ø 9.52	0.7	
ø12.70	0.8	
ø15.88	1.0	
ø15.88	0.8	C1220T-1/2H OR C1220T-H
ø19.05	0.9	
ø22.23	0.9	

ⓘ f Install refrigerant pipe depending on the outdoor unit capacity.

ⓘ f Make sure to use C1220T-1/2H (Semi-hard) pipe for more than Ø19.05 mm. In case of using C1220T-O (Soft) pipe for Ø19.05 mm, pipe may be broken, which can result in an injury.

\* ⓘ Temper grade and minimum thickness of the refrigerant pipe

## Keeping refrigerant pipe clean and dry

ⓘ f To prevent foreign materials or water from entering the pipe, pipes shall be sealed by caps.

## Cutting or flaring the pipes

1. Make sure that you prepared the required tools.
  - Pipe cutter, reamer, flaring tool and pipe holder, etc.
2. If you want to shorten the pipe, cut it with a pipe cutter ensuring that the cut edge remains at 90° with the side of the pipe.
  - There are some examples of correct and incorrect cut edges below.

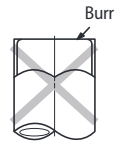
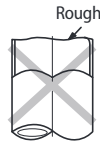
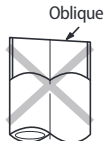
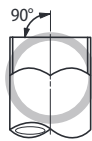
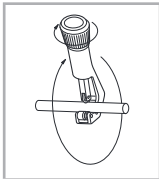

3. To prevent a gas leak, remove all burrs at the cut edge of the pipe with a reamer.

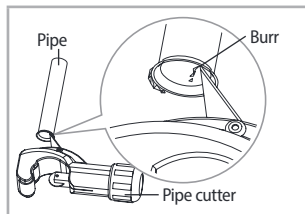

• Face the pipe down while removing the burrs to make sure that burrs do not get in to the pipe.

4. Put a flare nut slightly into the pipe and modify the flare.

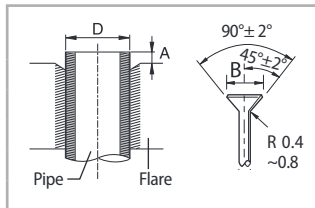

Outer diameter [D(mm)]	Depth [A (mm)]	Flaring Size [B (mm)]
ø 6.35	1.3	8.7~9.1
ø 9.52	1.8	12.8~13.2
ø 12.70	2.0	16.2~16.6
ø 15.88	2.2	19.3~19.7
ø19.05	2.2	23.6~24.0

5. Check that you flared the pipe correctly.

- Below figures shows some examples of incorrectly flared pipes.



Correct



Inclined



Damaged surface



Cracked



Uneven thickness

6. Align the pipes to connect them easily. Tighten the flare nuts first with your hands, and then with a torque wrench, applying the following torque:

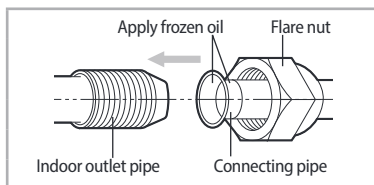

Outer diameter [mm(inch)]	Torque (N·m)
ø 6.35 (1/4")	14~18
ø 9.52 (3/8")	34~42
ø 12.70 (1/2")	49~61
ø 15.88 (5/8")	68~82
ø19.05 (3/4")	100~120



• Excessive torque can be cause of gas leakage.



• You must purge with oxygen free nitrogen while brazing.

# Refrigerant piping work

## Selecting the insulator of the refrigerant pipe

- ☐ f According to pipes size, insulate pipes on gas and liquid side by selecting appropriate insulations.
- ☐ f Standard condition is under a temperature of 30 °C and a humidity of 85 %. If the units are installed in extreme weather conditions, select the insulator by table below.

Pipe type	Pipe diameter (mm)	Thickness of insulator		Remarks
		Normal (Under 30 °C, 85 %)	High humidity (Over 30 °C, 85 %)	
		EPDM, NBR		
Liquid	ø6.35~ø19.05	9	9	The material shall has heat resistant over 120 °C
	ø12.70~ø19.05	13	13	
Gas	ø6.35	13	19	
	ø9.52	19	25	
	ø12.70			
	ø15.88			
	ø19.05			



CAUTION

- ☐ f Install the insulation not to be get wider and use the adhesives on the connection part of it to prevent moisture entering.
- ☐ f Wind the refrigerant pipe with insulation tape if it is exposed to outside sunlight.
- ☐ f Install the refrigerant pipe respecting that the insulation does not get thinner on the bent part or hanger of pipe.

## Insulating the refrigerant pipe

- ☐ f You must check if there is a gas leak before completing all the installation process.
- ☐ f Use EPDM insulation which meets the following condition.

Item	Unit	Standard	Remarks
Density	g/cm <sup>2</sup>	0.048~0.096	KSM 3014-01
Dimension change route by heat	%	-5 or less	
Water absorption rate	g/cm <sup>2</sup>	0.005 or less	
Thermal conductivity	kcal/m·h·°C	0.032 or less	KSL 9016-95
Moisture transpiration factor	ng/(m <sup>2</sup> ·s·Pa)	15 or less	KSM 3808-03
Moisture transpiration grade	{g/(m <sup>2</sup> ·24h)}	15 or less	KSA 1013-01
Formaldehyde dispersion	mg/L	-	KSF 3200-02
Oxygen rate	%	25 or less	ISO 4589-2-96

## Insulating the refrigerant pipe

- ☐ f Be sure to insulate the refrigerant pipe, joints and connections with class 'o' material.
- ☐ f If you insulate the pipes, the condensed water does not fall from the pipes and the capacity of the Air to Water Heat Pump is improved.
- ☐ f Check if there are any insulation cracks on the bent pipe.

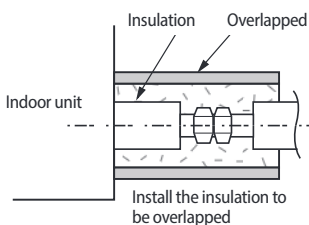
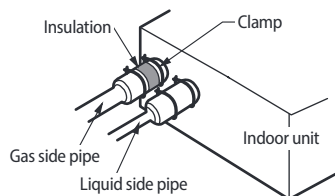

## Brazing the Pipe

- ☐ f Make sure that there is no moisture inside the pipe.
- ☐ f Make sure that there are no foreign materials and impurities in the pipe.

## Replacement of Nitrogen gas

1. Use oxygen free nitrogen gas when brazing the pipes as shown in the picture.
2. If you do not use Nitrogen gas when brazing the pipes, oxidation may form in the pipe. It can cause the damage of the compressor and valves.
3. Adjust the flow rate of the replacement with a pressure regulator to maintain 0.05 m<sup>3</sup>/h or more.
4. Perform brazing of the service valve after protecting the valve.

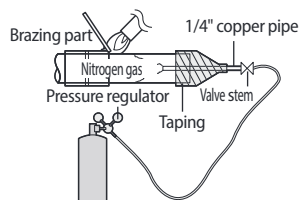

# Refrigerant piping work

## Performing the refrigerant gas leak test

- ❑ f Use a manifold gauge for R-410A to prevent the inflow of foreign substances and resist against the internal pressure.
- ❑ f Pressure test with dry oxygen free nitrogen only.

Apply pressure to the liquid side pipe and gas side pipe with Nitrogen gas of 4.1 MPa (41.8 kgf/cm<sup>2</sup>)

If you apply pressure more than 4.1MPa, the pipes may be damaged. Apply pressure using pressure regulator.

Keep it for minimum 24 hours to check if the pressure drops.

After applying Nitrogen gas, check the change of pressure using pressure regulator.

If the pressure drops, check if there is gas leak.

If the pressure is changed, apply soapy water to check the leak. Check the pressure of the Nitrogen gas again.

Maintain 1.0MPa of the pressure before performing vacuum drying and check further gas leak.

After checking first gas leak, maintain 1.0MPa to check further gas leak.

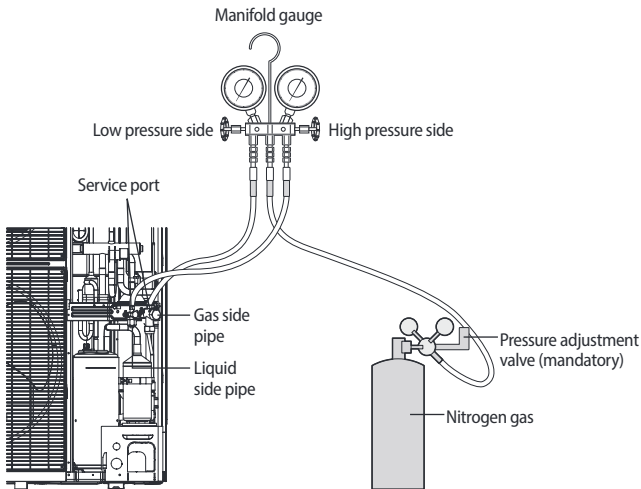

- \* ❑ Make sure to use a recommended bubble test solution for Gas Leak Test. Soap water could cause cracking of the flare nuts or lead to corrosion of flared joints.



You may get injured when the joint on the high pressure side detaches and the gas comes in contact with your body. Make sure to tighten the joint to prevent such accidents.

## Vacuum drying

- ❑ f Use the tools for R-410A only to prevent the inflow of foreign substances and resist against the internal pressure.
- ❑ f Use the vacuum pump with the check valve to prevent pump oil from flowing backward while the vacuum pump is stopped suddenly.
- ❑ f Use the vacuum pump that can be vacuumed up to 666.6Pa(5 mmHg).
- ❑ f Close the service valve of the liquid side pipe, gas side pipe completely when performing air tightening test or vacuum drying.

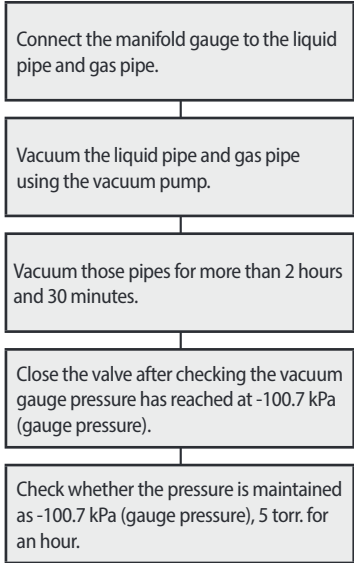
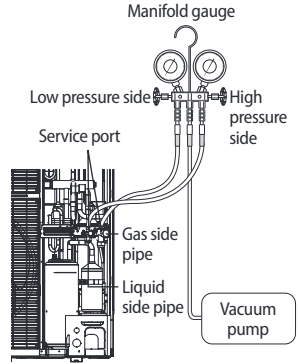

Make sure to install check valve to prevent pump oil from flowing into the pipe.

The time of vacuum drying may differ depending on the length of the pipe or outdoor temperature. Perform vacuum drying for at least 2 hours and 30 minutes.

Check the vacuum pressure using the vacuum gauge.

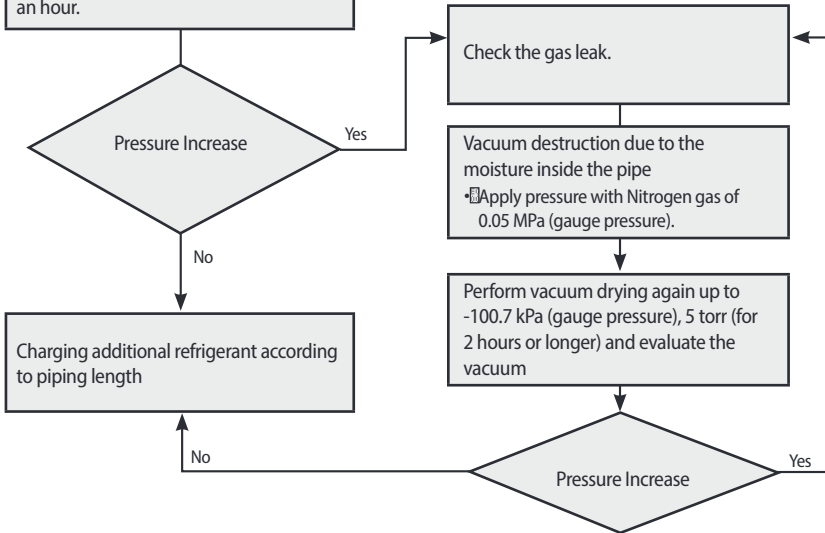

❑ f If the pressure rises in an hour, either water remains inside the pipe, or there will be a leak.

# Refrigerant piping work

## Selecting additional refrigerant charge

### \* Basic charge

The basic amount of refrigerant for outdoor unit charged in factory is:

Outdoor unit (Series)	Factory charge(kg)
AE090XEDEH	1.7
AE120XEDEH	2.98
AE140XEDEH	2.98
AE160XEDEH	2.98
AE090XEDGH	1.9
AE120XEDGH	2.98
AE140XEDGH	2.98
AE160XEDGH	2.98

### \* Charge additional refrigerant according to the total length of the pipe.

Each factory charging values are determined according to basic pipe length 15 m.

When extra pipe length are required, additional charging works must be implemented as describes below.

## Refrigerant Charging

### \* Additional charging amount is determined based on liquid pipe specifications.

Outdoor unit of liquid	ø6.35	ø9.52
Additional charging (g)	20 g/m	50 g/m

$$\text{Additional Charge(g)} = (L1-15)*20$$

$$\text{Additional Charge(g)} = (L2-15)*50$$



NOTE

• L1: Total length of liquid pipe Ø 6.35(m)\_Model : T T 090T T

• L2: Total length of liquid pipe Ø 9.52(m)\_Model : T T 120/140/160T T

Ex) Total length of liquid pipe =20 m

$$\text{Ø 6.35} = (20\text{m}-15\text{m}) \times 20\text{g/m} = 100 \text{ g (Model : T T 090T T)}$$

$$\text{Ø 9.52} = (20\text{m}-15\text{m}) \times 50\text{g/m} = 250 \text{ g (Model : T T 120/140/160T T)}$$



## Charging refrigerant

- ⓘ f The R-410A refrigerant is blended refrigerant. Add only liquid refrigerant.
- ⓘ f Measure the quantity of the refrigerant according to the length of the liquid side pipe. Add quantity of the refrigerant using a scale.

### Important information regulation regarding the refrigerant used

This product contains fluorinated greenhouse gases. Do not vent gases into the atmosphere.



ⓘ Inform user if system contains 5 tCO<sub>2</sub>e or more of fluorinated greenhouse gases. In this case, it has to be checked for leakage at least once every 12 months, according to regulation n°517/2014. This activity has to be covered by qualified personnel only. In case situation above (5 tCO<sub>2</sub>e or more of R-410A), installer (or recognized person which has responsibility for final check) has to provide a maintenance book, with all the information recorded according to REGULATION (EU) No 517/2014 OF THE EUROPEAN PARLIAMENT AND OF THE COUNCIL of 16 April 2014 on fluorinated greenhouse gases.

Please fill in the following indelible ink on the refrigerant charge label supplied with this product on and on this manual.

- ⓘ f ① The factory refrigerant charge of the product.
- ⓘ f ② The additional refrigerant amount charged in the field.
- ⓘ f ①+② The total refrigerant charge.



NOTE

- a. Factory refrigerant charge of the product: See unit name plate.
- b. Additional refrigerant amount charged in the field. (Refer to the above information for the quantity of refrigerant replenishment.)
- c. Total refrigerant charge.
- d. Refrigerant cylinder and manifold for charging.

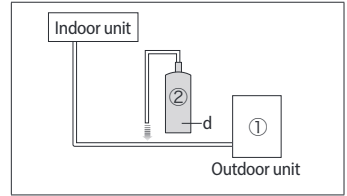

Unit	kg	tCO <sub>2</sub> e
①, a		
②, b		
① + ②, c		

Refrigerant type	GWP value
R-410A	2088

- \* ⓘ GWP=Global Warming Potential
- \* ⓘ Calculating tCO<sub>2</sub>e : kg x GWP / 1000

- ⓘ f Before charging, check whether the refrigerant cylinder has a siphon attached or not and position the cylinder accordingly.

#### Charging using a cylinder with a siphon attached

Charge the liquid refrigerant with the cylinder in upright position.

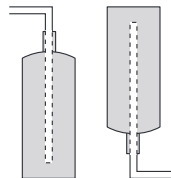

#### Charging using a cylinder without a siphon attached

Charge the liquid refrigerant with the cylinder in up-side-down position.

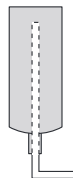

# Refrigerant piping work

## Adding refrigerant

- ▣ f The R-410A refrigerant is blended refrigerant. Add only liquid refrigerant.
- ▣ f Measure the quantity of the refrigerant depending on the length of the liquid side pipe. Add fixed quantity of the refrigerant using a scale.
- \* ▣ Adding refrigerants in cooling conditions

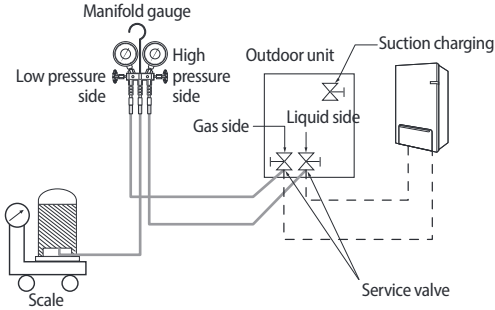

- \* ▣ Adding refrigerants in heating conditions

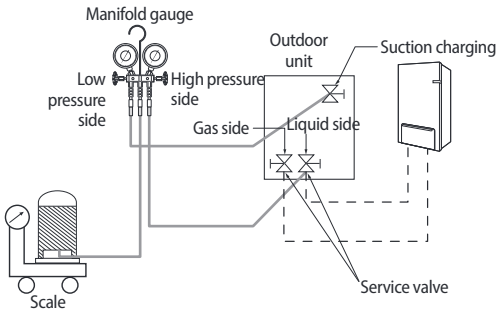

- ▣ f Connect the manifold gauge and purge the manifold gauge.
- ▣ f Open the manifold gauge valve of the liquid side service valve and add the liquid refrigerant.
- ▣ f If you cannot fully recharge the additional refrigerant while the outdoor unit is stopped, use the key on the outdoor unit PCB to recharge the remaining refrigerant.
- ▣ f Adding the cooling refrigerant
  - 1) Press the function key for adding refrigerant in cooling mode.
  - 2) After 20 minutes of operation, open the valve on gas side.
  - 3) Open the valve for low pressure side on the manifold gauge to recharge the remaining refrigerant.

### f Adding the heating refrigerant

- 1) When recharging the heating refrigerant, connect the low pressure pipe from manifold gage to the suction charging port.
- 2) Press the function key for adding refrigerant in heating mode.
- 3) After 20 minutes of operation, open the valve on suction charge port.
- 4) Open the valve for low pressure side on the manifold gage to recharge the remaining refrigerant.



Open the gas side and liquid side service valve completely after charging the refrigerant. (If you operate the Air to Water Heat Pump with the service valve closed, the important parts may be damaged.)

### To close the valve stem

1. Open the cap and turn the valve stem clockwise by using a hexagonal wrench.

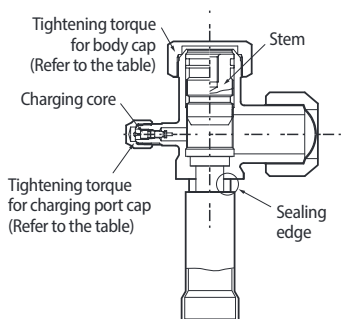

Outer Diameter (mm)	Tightening torque (N·m)		Operating torque (N·m)
	Body cap	Charging port cap	Stem
ø6.35	20 ~ 25	10 ~ 12	Max 5
ø9.52			Max 5
ø12.70			Max 5
ø15.88			Max 5
ø19.05			Max 12

\* 1kgf·cm

2. Tighten the valve stem until it reached the sealing edge.



Do not apply excessive force to the valve stem and always use special instruments. Otherwise, the contact surface between valve stem and sealing edge can be damaged and refrigerant can leak through this damaged surface.  
If refrigerant would leak, turn the valve stem back by half and tighten the valve stem again, then check the leakage. If there is no leakage any more, tighten the valve stem entirely.

3. Tighten the cap securely.

### To open the valve stem

1. Remove the cap.
2. Turn the valve stem counterclockwise by using a hexagonal wrench.
3. Turn the valve stem until it is stopped.
4. Tighten the cap securely.



When you use the service port, always use a charging hose, too.  
Check the leakage of refrigerant gas after tightening the cap.  
Must use a spanner and wrench when you open/tighten the valve stem.

# Checking correct grounding

If the power distribution circuit does not have a grounding or the grounding does not comply with specifications, an grounding electrode must be installed. The corresponding accessories are not supplied with the Air to Water Heat pump.

1. Select an grounding electrode that complies with the specifications given in the illustration.

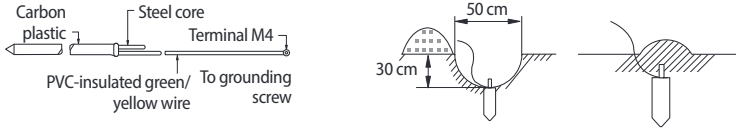

2. Connect the flexible hose to the flexible hose port.

- ⓘ In damp hard soil rather than loose sandy or gravel soil that has a higher grounding resistance.
- ⓘ Away from underground structures or facilities, such as gas pipes, water pipes, telephone lines and underground cables.
- ⓘ At least two metres away from a lightning conductor grounding electrode and its cable.



ⓘ The grounding wire for the telephone line cannot be used to ground the Air to Water Heat pump.

3. Finish wrapping insulating tape around the rest of the pipes leading to the outdoor unit.

4. Install a green/yellow coloured grounding wire :

- ⓘ If the grounding wire is too short, connect an extension lead, in a mechanical way and wrapping it with insulating tape (do not bury the connection).
- ⓘ Secure the grounding wire in position with staples.



ⓘ If the grounding electrode is installed in an area of heavy traffic, its wire must be connected securely.

5. Carefully check the installation, by measuring the grounding resistance with a ground resistance tester. If the resistance is above required level, drive the electrode deeper into the ground or increase the number of grounding electrodes.
6. Connect the grounding wire to the electrical component box inside of the outdoor unit.

# Setting the option switch and function of the keys

## Testing operations

1. Check the power supply between the outdoor unit and the auxiliary circuit breaker.
  - ⓘ 1 phase power supply : L, N
  - ⓘ 3 phases power supply : R,S,T,N
2. Check that you have connected the power and communication cables correctly.(If the power cable and communication cables one mixed up or connected incorrectly, the PCB will be damaged.)

3. Press K1 or K2 on the outdoor unit PCB to run the test mode and stop.

KEY	KEY operation	7-segment display
K1	Press once : Heating test run	"F" "1" "BLANK" "BLANK"
	Press twice : Defrost test run	"F" "3" "BLANK" "BLANK"
	Press 3times : Finishing test mode	-
K2	Press once : Cooling test run (Heating Only : skip)	"F" "2" "BLANK" "BLANK"
	Press twice : Output signal test run	"F" "4" "BLANK" "BLANK"
	Press 3 times : Finishing test mode	-
K3	Reset	-
K4	View mode	Refer to View mode display

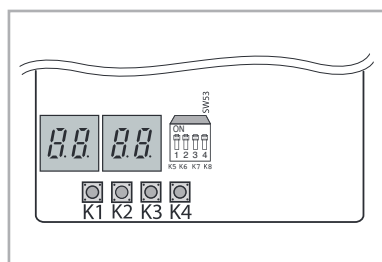
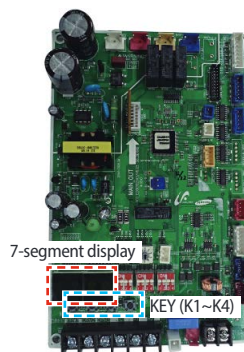

4. View Mode : When the K4 switch is pressed, you can see information about our system state as below.

Number of press	Display contents	Display				Units
		Segment 1	Segment 2	Segment 3	Segment 4	
0	Communication State	10s digit of Tx	1s digit of Tx	10s digit of Rx	1s digit of Rx	-
1	Order frequency	1	100s digit	10s digit	1s digit	Hz
2	Current frequency	2	100s digit	10s digit	1s digit	Hz
3	Pump output	3	100s digit	10s digit	1s digit	%
4	Outdoor air sensor	4	+/-	10s digit	1s digit	°C
5	Discharge sensor	5	100s digit	10s digit	1s digit	°C
6	Eva in sensor	6	+/-	10s digit	1s digit	°C
7	Inlet water sensor	7	+/-	10s digit	1s digit	°C
8	Outlet water sensor	8	+/-	10s digit	1s digit	°C
9	Cond sensor	9	+/-	10s digit	1s digit	°C
10	Current	A	10s digit	1s digit	First decimal	A
11	Fan RPM	B	1000s digit	100s digit	10s digit	rpm
12	Target discharge temperature	C	100s digit	10s digit	1s digit	°C
13	EEV	D	1000s digit	100s digit	10s digit	step

Number of press	Display contents	Display				Units
		Segment 1	Segment 2	Segment 3	Segment 4	
14	Protective control	E	0 : Cooling 1 : Heating	Protective control 0 : No protective control 1 : Freezing 2 : Defrosting 3 : Over-load 4 : Discharge 5 : Total current	Frequency status 0 : Normal 1 : Hold 2 : Down 3 : Up_limit 4 : Down_limit	-
15	IPM temp.	F	+/-	10s digit	1s digit	°C
long-1	Main Micom version	Year(Dec)	Month(Hex)	Day(two digit)	Day(One digit)	-
long-1 and 1	Inverter Micom version	Year(Hex)	Month(Hex)	Day(two digit)	Day(One digit)	-
long-1 and 2	EEPROM version	Year(Hex)	Month(Hex)	Day(two digit)	Day(One digit)	-

### 5. DIP Switching setting

KEY	ON (default)	OFF	Remark	
K5	Heat Pump	Heating Only		
K6	Anti-stack snow mode OFF	Anti-stack snow mode ON		
K7	Silence operation		In silence mode, no guarantee of capacity	
K8	K7	K8		Mode
	ON	ON		Silence mode Step 1
	ON	OFF		Silence mode Step 2
	OFF	ON		Silence mode Step 3
OFF	OFF	Silence mode Step 1		

### 6. Key function setting

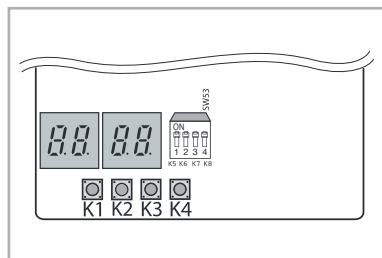

## Setting the option

1. Press and hold K2 to enter the option setting. (Only available when the operation is stopped)
  - If you enter the option setting, display will show the following.



- Seg1 and Seg2 will display the number for selected option.
  - Seg3 and Seg4 will display the number for set value of the selected option.
2. If you have entered option setting, you can shortly press the K1 switch to adjust the value of the Seg1, Seg2 and select the desired option.

Example)

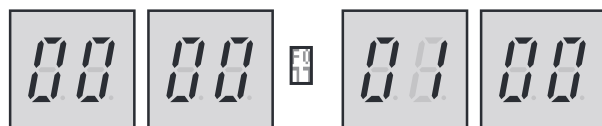

3. If you have selected desired option, you can shortly press the K2 switch to adjust the value of the Seg3, Seg4 and change the function for the selected option.

Example)

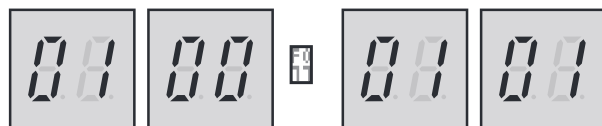

4. After selecting the function for options, press and hold the K2 switch for 2 seconds. Edited value of the option will be saved when entire segments blinks and tracking mode begins.



Edited option will not be saved if you do not end the option setting as explained in above instruction.

- \* While you are setting the option, you may press and hold the K1 button to reset the value to previous setting.
- \* If you want to restore the setting to factory default, press and hold the K4 button while you are in the option setting mode.
  - If you press and hold the K4 button, setting will be restored to factory default but it doesn't mean that restored setting is saved. Press and hold the K2 button. When the segments shows that tracking mode is in progress, setting will be saved.

Optional item	SEG1	SEG2	SEG3	SEG4	Function of the option	Remarks
Channel address	0	0	A	U	Automatic setting(Factory default)	Address for classifying the product from upper level 0 ~ 15 controller (DMS, S-NET 3, etc)
	0	0	0~15		Manual addressing	
Base Heater	0	1	0	0	Use(Factory default)	-
	0	1	0	1	Not use	-

# Setting the option switch and function of the keys

## Pump down procedure

### Objective of pump down

For product repairs and indoor unit relocation, pump down operation must be done recover the refrigerant into the outdoor unit.

### Cautions when performing pump down

- ❑ f Product limits amount of refrigerant in the outdoor unit due to slim design.
- ❑ f Collect the majority of the refrigerant in the system in an empty refrigerant vessel and perform a pump down operation with remaining refrigerant. Maximum amount of refrigerant is 5Kg.
- ❑ f If the amount of refrigerant exceeds maximum allowable limit, increased pressure may cause compressor trip or a burn out.

### Cautions when performing pump down

1. Close the manifold gauge.
2. Close the liquid side service valve.
3. Set the unit to the Cooling Test mode by pushing K2 button 1 time.
4. Observe low pressure side using manifold gauge when the compressor operating.
5. When the pressure gauge indicates "0" turn the low pressure side valve counter clockwise to close.
6. Stop operation of the unit by pushing K3 button.
7. Close the each cap of valve.



- ❑ Use a transfer cylinder when recovering refrigerant to be reused. Using modified refrigerant vessel may cause explosion and cause damage or personal injury.



### Relocation of the Air to water heat pump

NOTE

- ❑ Refer to this procedure when the unit is relocated.
- ❑ Carry out the pump down procedure. (Refer to the details of 'pump down'.)
- ❑ Collecting refrigerant may be hard, since multi type products exceeds allowable charging amount of refrigerant in the outdoor unit to support long piping. (Refer to page 36.)
- ❑ Remove the power cord.
- ❑ Disconnect the assembly cable from the indoor and outdoor units.
- ❑ Remove the flare nut connecting the indoor unit and the pipe.
- ❑ At this time, cover the pipe of the indoor unit and the other pipe using a cap or vinyl plug to avoid foreign material entering.
- ❑ Disconnect the pipe connected to the outdoor unit. At this time, cover the valve of the outdoor unit and the other pipe using a cap or vinyl plug to avoid foreign material entering.
- ❑ Make sure you do not bend the connection pipes in the middle and store together with the cables.
- ❑ Move the indoor and outdoor units to a new location.
- ❑ Remove the mounting plate for the indoor unit and move it to a new location.



## Collecting refrigerant in refrigerant vessel before pump down operation

If the amount of refrigerant in the system exceeded the maximum allowable limit, reduce the amount of the refrigerant by following the below instruction before pump down operation.

1. Prepare an exclusive rechargeable refrigerant vessel, scale and a manifold gauge.
2. Check the amount of refrigerant in the entire system.
3. Connect a refrigerant vessel to an outdoor unit and operated about 50 % of the indoor unit in cooling mode.
4. After 10 minutes of cooling operation, check the pressure on high pressure side with the manifold gauge. If the pressure on the high pressure side is over 3.0 MPa (30.59 kgf/cm<sup>2</sup>), reduce the number of operating indoor unit to decrease the pressure below 3.0 MPa (30.59 kgf/cm<sup>2</sup>).
5. When the pressure becomes lower than 3.0 MPa (30.59 kgf/cm<sup>2</sup>) open the manifold gauge valve ② which is connected to a liquid side. Then, open the valve on the refrigerant vessel for the refrigerant to flow from the liquid side pipe to a vessel.
6. Check the weight difference with the scale. When desired amount of the refrigerant is collected into the vessel, close the valve and remove the manifold gauge.
7. Make sure that the amount of the refrigerant in the vessel is about 50 % of the entire system.
8. Measure the amount of refrigerant correctly to not exceed amount of collected refrigerant.

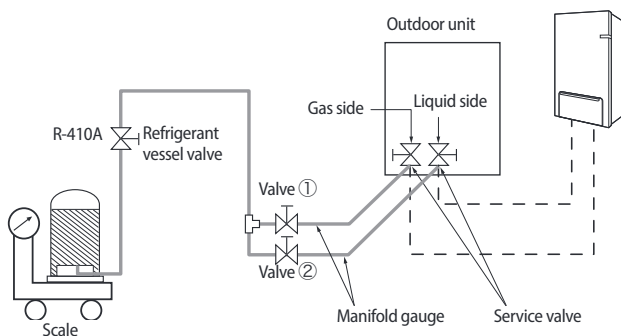

# Completing the installation

☑ f Check the following after completing the installation.

Installation	Outdoor unit	<ul style="list-style-type: none"><li>☑ Check the external surface and the inside of the outdoor unit.</li><li>☑ Is there any possibility of short circuit?</li><li>☑ Is the place well-ventilated and ensures space for service?</li><li>☑ Is the outdoor unit fixed securely?</li></ul>
	Indoor unit	<ul style="list-style-type: none"><li>☑ Check the external surface and the inside of the indoor unit.</li><li>☑ Is the place well-ventilated and ensures space for service?</li><li>☑ Check if the center of the indoor unit is ensured and it is installed horizontally.</li></ul>
Adding refrigerant		<ul style="list-style-type: none"><li>☑ Are the length and the difference between the refrigerant pipes within the allowable range?</li><li>☑ Is the pipe properly insulated?</li><li>☑ Is the quantity of the additional refrigerant correctly weighed in?</li></ul>
Installing the drain pipe		<ul style="list-style-type: none"><li>☑ Check the drain pipe of the outdoor unit and the indoor unit.</li><li>☑ Have you completed the drain test?</li><li>☑ Is the drain pipe properly insulated?</li></ul>
Installing the wiring		<ul style="list-style-type: none"><li>☑ Have you performed the earthing work 3 to the outdoor unit?</li><li>☑ Is 2-core cable used?</li><li>☑ Is the length of the wire is in the limited range?</li><li>☑ Is the wiring route correct?</li></ul>

# Final checks and trial operation

## Inspection before test operation

1. Check the power cable and communication cable of the indoor and outdoor unit.
2. Check the power supply between the outdoor unit and the cabinet panel.
  - Check the 220-240 V~ / 380-415 V~ with the voltage meter.
3. Once the outdoor unit is turned on, it performs the tracking to check the connected indoor unit and options.

## Test operation

1. **Run the unit by KEY MODE or controller.**
  - Inspect the compressor sound during the initial operation. If roaring sound is heard, stop operation.
2. **Check the indoor and outdoor units' running status.**
  - Indoor and outdoor unit's abnormal running noise.
  - Proper drainage from indoor unit in cooling mode.
  - Check detail running status using S-NET program.
3. **Finish test.**
4. **Explain to the customer how to use the Air to Water Heat Pump following the user's manual.**



# Trouble shooting



- Incorrect handling of thermostat, safety valve or other valves may lead to tank rupture. When servicing the unit follow instructions carefully:
- Always turn off main power supply when water supply is being shut off.
- Test the free operation of the safety valve regularly by opening the valve ensuring the water flows freely.
- Electrical connection and all servicing of the electrical components should only be carried out by an authorized electrician.
- Fitting and all servicing of plumbing fixtures should only be carried out by an authorized installer.
- When replacing the thermostat, safety valve or any other valve or part supplied with this unit, use only approved parts of the same specification.

## Error codes

If the unit has some problems and does not work normally, error code is shown on the OUTDOOR UNIT main PBA or LCD of the wired remote controller.

Display	Explanation	Error Source
101	Hydro Unit / Outdoor Unit communication connection error	Hydro Unit
122	EVA Inlet temp sensor SHORT or OPEN	Hydro Unit
123	EVA Outlet temp sensor SHORT or OPEN	Hydro Unit
162	EEPROM Error	Hydro Unit
198	Error of Terminal Block's Thermal Fuse(Open)	Hydro Unit
201	Hydro Unit / Outdoor Unit communication error(Matching error)	Hydro Unit/Outdoor Unit
202	Hydro Unit / Outdoor Unit communication error(3 min)	Hydro Unit/Outdoor Unit
203	Communication error between INVERTER and MAIN MICOM (4 min)	Outdoor Unit
221	Outdoor Unit air temperature sensor error	Outdoor Unit
231	Condenser temperature sensor error	Outdoor Unit
251	Discharge temperature sensor error	Outdoor Unit
320	OLP sensor error	Outdoor Unit
403	Detection of freezing (During cooling operation)	Outdoor Unit
404	Protection of Outdoor Unit when it is overload (during Safety Start, Normal operation state)	Outdoor Unit
407	Comp down due to high pressure	Outdoor Unit
416	Discharge of a compressor is overheated	Outdoor Unit
419	OUTDOOR UNIT EEV operation error	Outdoor Unit
425	Power source line missing error (only for 3-phase model)	Outdoor Unit
440	Heating operation blocked (outdoor temperature over 35 °C)	Outdoor Unit
441	Cooling operation blocked (outdoor temperature under 9 °C)	Outdoor Unit
458	OUTDOOR UNIT fan1 error	Outdoor Unit
461	[Inverter] Compressor startup error	Outdoor Unit
462	[Inverter] Total current error/PFC over current error	Outdoor Unit

Display	Explanation	Error Source
463	OLP is overheated	Outdoor Unit
464	[Inverter] IPM over current error	Outdoor Unit
465	Compressor overload error	Outdoor Unit
466	DC LINK over/low voltage error	Outdoor Unit
467	[Inverter] Compressor rotation error	Outdoor Unit
468	[Inverter] Current sensor error	Outdoor Unit
469	[Inverter] DC LINK voltage sensor error	Outdoor Unit
470	Outdoor unit EEPROM Read/Write Error	Outdoor Unit
471	Outdoor unit EEPROM Read/Write Error(OTP error)	Outdoor Unit
474	IPM(IGBT Module) or PFCM temperature sensor Error	Outdoor Unit
475	Outdoor Unit Fan2 error	Outdoor Unit
484	PFC Overload Error	Outdoor Unit
485	Input current sensor error	Outdoor Unit
500	IPM is overheated	Outdoor Unit
554	Gas leak error	Outdoor Unit
590	Inverter EEPROM Checksum error	Outdoor Unit
601	Communication error between the Hydro Unit and wired remote controller	Hydro Unit
604	Communication tracking error between the Hydro Unit and wired remote controller	Hydro Unit
653	Wired remote controller temp sensor SHORT or OPEN	Hydro Unit, Wired Remote Controller
654	Memory(EEPROM) Read/Write Error(Wired remote Controller data error)	Hydro Unit, Wired Remote Controller
901	Water inlet (PHE) temperature sensor error(open/short)	Hydro Unit
902	Water outlet (PHE) temperature sensor error(open/short)	Hydro Unit
903	Water outlet (backup heater) temperature sensor error	Hydro Unit
904	DHW tank temperature sensor error	Hydro Unit
906	Refrigerant gas inlet (PHE) temperature sensor (open/short)	Outdoor Unit
911	Flow switch and water pump error (F/S signal is OFF for 15 sec. during the water pump signal is ON)	Hydro Unit
912	Flow switch and water pump error (F/S signal is ON for 10 min. during the Water pump signal is OFF)	Hydro Unit
916	Mixing valve sensor error	Hydro Unit

# COMMISSION REGULATION (EU) No 813/2013 <sup>1)</sup>

## ECODESIGN REQUIREMENTS FOR SPACE HEATER <sup>1)</sup>

A	Model(s) : AE090JXEDEH/AE090JNYDEH
B	Air-to-water heat pump : yes
C	Water-to-water heat pump : no
D	Brine-to-water heat pump : no
E	Low-temperature heat pump : no
F	Equipped with a supplementary heater : no
G	Heat pump combination heater : no
H	Parameters shall be declared for medium-temperature application, except for low-temperature heat pumps. For low-temperature heat pump, parameters shall be declared for low-temperature application.
I	Parameters shall be declared for average climate conditions.

	Item <sup>(1)</sup>	Symbol <sup>(2)</sup>	Value <sup>(3)</sup>	Unit <sup>(4)</sup>
N	Rated heat output <sup>(1)</sup>	Prated <sup>(6)</sup>	6	kW
Q	Declared capacity for heating for part load at indoor temperature 20 °C and outdoor temperature Tj			
-	Tj = -7 °C	Pdh	5.5	kW
	Tj = +2 °C	Pdh	3.3	kW
	Tj = +7 °C	Pdh	2.1	kW
	Tj = +12 °C	Pdh	1.0	kW
T	Tj = bivalent temperature	Pdh	6.2	kW
U	Tj = operation limit temperature	Pdh	6.2	kW
V	For air-to-water heat pumps Tj = -15 °C (if TOL < -20 °C)	Pdh	-	kW
W	Bivalent temperature	Tbiv	-10	°C
Y	Cycling interval capacity for heating	Pcyc	-	kW
AB	Degradation co-efficient <sup>(7)</sup>	Cdh	0.9	-
AD	Power consumption in modes other than active mode			
AF	Off mode	Poff	0.080	kW
AG	Thermostat-off mode	Pto	0.011	kW
AH	Standby mode	Psb	0.011	kW
AI	Crankcase heater mode	Pck	0.000	kW
AK	Other items			
AL	Capacity control		variable <sup>(8A)</sup>	
AP	Sound power level, indoors/ outdoors	Lwa	40/64	dB
AQ	Emissions of nitrogen oxides	NOx	-	mg/kWh
AS	For heat pump combination heater			
AT	Declared load profile		-	
AV	Daily electricity consumption	Qelec	-	kWh
AX	Contact details	http://www.samsung.com		

	Item <sup>(1)</sup>	Symbol <sup>(2)</sup>	Value <sup>(3)</sup>	Unit <sup>(4)</sup>
P	Seasonal space heating energy efficiency	$\eta_p$	128	%
R	Declared coefficient of performance or primary energy ratio for part load at indoor temperature 20 °C and outdoor temperature Tj			
-	Tj = -7 °C	COPd <sup>(5)</sup>	1.93	-
	Tj = +2 °C	COPd <sup>(5)</sup>	3.11	-
	Tj = +7 °C	COPd <sup>(5)</sup>	4.30	-
	Tj = +12 °C	COPd <sup>(5)</sup>	6.64	-
T	Tj = bivalent temperature	COPd <sup>(5)</sup>	1.72	-
U	Tj = operation limit temperature	COPd <sup>(5)</sup>	1.72	-
V	For air-to-water heat pumps Tj = -15 °C (if TOL < -20 °C)	COPd <sup>(5)</sup>	-	-
X	For air-to-water heat pumps: Operation limit temperature	TOL	-10	°C
Z	Cycling interval efficiency	COPcyc <sup>(8A)</sup>	-	-
AC	Heating water operating limit temperature	WTOL	-	°C
AE	Supplementary heater			
N	Rated heat output <sup>(1)</sup>	Psup	-	kW
AJ	Type of energy input			
AK	Other items			
AN	For air-to-water heat pumps : Rated air flow rate, outdoors	-	53	m <sup>3</sup> /h <sup>(8A)</sup>
AR	For water-/brine-to-water heat pumps: Rated brine or water flow rate, outdoor heat exchanger	-	-	m <sup>3</sup> /h <sup>(8A)</sup>
AS	For heat pump combination heater			
AU	Water heating energy efficiency	$\eta_{wh}$	-	%
AW	Daily fuel consumption	Qfuel	-	kWh

AY <sup>(1)</sup> For heat pump space heaters and heat pump combination heaters, the rated that output Prated is equal to the design load for heating Pdesignh, and the rated heat output of a supplementary heater Psup is equal to the supplementary capacity for heating sup(Tj).

AZ <sup>(7)</sup> If Cdh is not determined by measurement then the default degradation coefficient is Cdh = 0.9.

BA <sup>(1)</sup> Precautions as described in the installation/user manual must be taken when assembling, installing and maintaining this product.

BB <sup>(2)</sup> If you are a professional looking for information on non-destructive disassembly and dismantling, please send an email to: erims.sec@samsung.com

A	Model(s) : AE090JXEDGH/AE090JNYDGH
B	Air-to-water heat pump : yes
C	Water-to-water heat pump : no
D	Brine-to-water heat pump : no
E	Low-temperature heat pump : no
F	Equipped with a supplementary heater : no
G	Heat pump combination heater : no
H	Parameters shall be declared for medium-temperature application, except for low-temperature heat pumps. For low-temperature heat pump, parameters shall be declared for low-temperature application.
I	Parameters shall be declared for average climate conditions.

	Item <sup>(1)</sup>	Symbol <sup>(2)</sup>	Value <sup>(3)</sup>	Unit <sup>(4)</sup>
N	Rated heat output <sup>(1)</sup>	Prated <sup>(6)</sup>	6	kW
Q	Declared capacity for heating for part load at indoor temperature 20 °C and outdoor temperature Tj			
-	Tj = -7 °C	Pdh	5.7	kW
	Tj = +2 °C	Pdh	3.4	kW
	Tj = +7 °C	Pdh	2.2	kW
	Tj = +12 °C	Pdh	1.0	kW
T	Tj = bivalent temperature	Pdh	6.4	kW
U	Tj = operation limit temperature	Pdh	6.4	kW
V	For air-to-water heat pumps Tj = -15 °C (if TOL < -20 °C)	Pdh	-	kW
W	Bivalent temperature	Tbiv	-10	°C
Y	Cycling interval capacity for heating	Pcyh	-	kW
AB	Degradation co-efficient <sup>(7)</sup>	Cdh	0.9	-
AD	Power consumption in modes other than active mode			
AF	Off mode	Poff	0.080	kW
AG	Thermostat-off mode	Pto	0.011	kW
AH	Standby mode	Psa	0.011	kW
AI	Crankcase heater mode	Pcc	0.000	kW
AK	Other items			
AL	Capacity control		variable <sup>(8A)</sup>	
AP	Sound power level, indoors/ outdoors	Lwa	40/64	dB
AQ	Emissions of nitrogen oxides	NOx	-	mg/kWh
AS	For heat pump combination heater			
AT	Declared load profile		-	
AV	Daily electricity consumption	Qelec	-	kWh
AX	Contact details	http://www.samsung.com		

	Item <sup>(1)</sup>	Symbol <sup>(2)</sup>	Value <sup>(3)</sup>	Unit <sup>(4)</sup>
P	Seasonal space heating energy efficiency	$\eta_p$	131	%
R	Declared coefficient of performance or primary energy ratio for part load at indoor temperature 20 °C and outdoor temperature Tj			
-	Tj = -7 °C	COPd <sup>(5)</sup>	2.10	-
	Tj = +2 °C	COPd <sup>(5)</sup>	3.19	-
	Tj = +7 °C	COPd <sup>(5)</sup>	4.24	-
	Tj = +12 °C	COPd <sup>(5)</sup>	6.37	-
T	Tj = bivalent temperature	COPd <sup>(5)</sup>	1.74	-
U	Tj = operation limit temperature	COPd <sup>(5)</sup>	1.74	-
V	For air-to-water heat pumps Tj = -15 °C (if TOL < -20 °C)	COPd <sup>(5)</sup>	-	-
X	For air-to-water heat pumps: Operation limit temperature	TOL	-10	°C
Z	Cycling interval efficiency	COPcyc <sup>(8A)</sup>	-	-
AC	Heating water operating limit temperature	WTOL	-	°C
AE	Supplementary heater			
N	Rated heat output <sup>(1)</sup>	Psup	-	kW
AJ	Type of energy input			
AK	Other items			
AN	For air-to-water heat pumps : Rated air flow rate, outdoors	-	53	m <sup>3</sup> /h <sup>(6A)</sup>
AR	For water-/brine-to-water heat pumps: Rated brine or water flow rate, outdoor heat exchanger	-	-	m <sup>3</sup> /h <sup>(6A)</sup>
AS	For heat pump combination heater			
AU	Water heating energy efficiency	$\eta_{wh}$	-	%
AW	Daily fuel consumption	Qfuel	-	kWh

AY <sup>(1)</sup> For heat pump space heaters and heat pump combination heaters, the rated that output Prated is equal to the design load for heating Pdesignh, and the rated heat output of a supplementary heater Psup is equal to the supplementary capacity for heating sup(Tj).

AZ <sup>(7)</sup> If Cdh is not determined by measurement then the default degradation coefficient is Cdh = 0.9.

BA <sup>(1)</sup> Precautions as described in the installation/user manual must be taken when assembling, installing and maintaining this product.

BB <sup>(2)</sup> If you are a professional looking for information on non-destructive disassembly and dismantling, please send an email to: erims.sec@samsung.com

# COMMISSION REGULATION (EU) No 813/2013 <sup>1)</sup>

A	Model(s) : AE120JXEDEH/AE160JNYDEH
B	Air-to-water heat pump : yes
C	Water-to-water heat pump : no
D	Brine-to-water heat pump : no
E	Low-temperature heat pump : no
F	Equipped with a supplementary heater : no
G	Heat pump combination heater : no
H	Parameters shall be declared for medium-temperature application, except for low-temperature heat pumps. For low-temperature heat pump, parameters shall be declared for low-temperature application.
I	Parameters shall be declared for average climate conditions.

	Item <sup>(1)</sup>	Symbol <sup>(2)</sup>	Value <sup>(3)</sup>	Unit <sup>(4)</sup>
N	Rated heat output <sup>(1)</sup>	Prated <sup>(6)</sup>	8	kW
Q	Declared capacity for heating for part load at indoor temperature 20 °C and outdoor temperature Tj			
-	Tj = -7 °C	Pdh	7.1	kW
	Tj = +2 °C	Pdh	4.3	kW
	Tj = +7 °C	Pdh	2.8	kW
	Tj = +12 °C	Pdh	1.2	kW
T	Tj = bivalent temperature	Pdh	8.0	kW
U	Tj = operation limit temperature	Pdh	8.0	kW
V	For air-to-water heat pumps Tj = -15 °C (if TOL < -20 °C)	Pdh	-	kW
W	Bivalent temperature	Tbiv	-10	°C
Y	Cycling interval capacity for heating	Pcyc	-	kW
AB	Degradation co-efficient <sup>(7)</sup>	Cdh	0.9	-
AD	Power consumption in modes other than active mode			
AF	Off mode	Poff	0.080	kW
AG	Thermostat-off mode	Pto	0.011	kW
AH	Standby mode	Psa	0.011	kW
AI	Crankcase heater mode	Pcx	0.000	kW
AK	Other items			
AL	Capacity control		variable <sup>(8A)</sup>	
AP	Sound power level, indoors/ outdoors	Lwa	47/64	dB
AQ	Emissions of nitrogen oxides	NOx	-	mg/kWh
AS	For heat pump combination heater			
AT	Declared load profile		-	
AV	Daily electricity consumption	Qelec	-	kWh
AX	Contact details	http://www.samsung.com		

	Item <sup>(1)</sup>	Symbol <sup>(2)</sup>	Value <sup>(3)</sup>	Unit <sup>(4)</sup>
P	Seasonal space heating energy efficiency	$\eta_p$	112	%
R	Declared coefficient of performance or primary energy ratio for part load at indoor temperature 20 °C and outdoor temperature Tj			
-	Tj = -7 °C	COPd <sup>(5)</sup>	1.77	-
	Tj = +2 °C	COPd <sup>(5)</sup>	2.74	-
	Tj = +7 °C	COPd <sup>(5)</sup>	4.51	-
	Tj = +12 °C	COPd <sup>(5)</sup>	7.02	-
T	Tj = bivalent temperature	COPd <sup>(5)</sup>	1.62	-
U	Tj = operation limit temperature	COPd <sup>(5)</sup>	1.62	-
V	For air-to-water heat pumps Tj = -15 °C (if TOL < -20 °C)	COPd <sup>(5)</sup>	-	-
X	For air-to-water heat pumps: Operation limit temperature	TOL	-10	°C
Z	Cycling interval efficiency	COPcyc <sup>(6A)</sup>	-	-
AC	Heating water operating limit temperature	WTOL	-	°C
AE	Supplementary heater			
N	Rated heat output <sup>(7)</sup>	Psup	-	kW
AJ	Type of energy input			
AK	Other items			
AN	For air-to-water heat pumps : Rated air flow rate, outdoors	-	108	m <sup>3</sup> /h <sup>(8A)</sup>
AR	For water-/brine-to-water heat pumps: Rated brine or water flow rate, outdoor heat exchanger	-	-	m <sup>3</sup> /h <sup>(8A)</sup>
AS	For heat pump combination heater			
AJ	Water heating energy efficiency	$\eta_{wh}$	-	%
AW	Daily fuel consumption	Qfuel	-	kWh

AY <sup>(7)</sup> For heat pump space heaters and heat pump combination heaters, the rated that output Prated is equal to the design load for heating Pdesignh, and the rated heat output of a supplementary heater Psup is equal to the supplementary capacity for heating sup(Tj).

AZ <sup>(7A)</sup> If Cdh is not determined by measurement then the default degradation coefficient is Cdh = 0.9.

BA <sup>(1)</sup> Precautions as described in the installation/user manual must be taken when assembling, installing and maintaining this product.

BB <sup>(2)</sup> If you are a professional looking for information on non-destructive disassembly and dismantling, please send an email to: erims.sec@samsung.com



A	Model(s) : AE120JXEDGH/AE160JNYDGH
B	Air-to-water heat pump : yes
C	Water-to-water heat pump : no
D	Brine-to-water heat pump : no
E	Low-temperature heat pump : no
F	Equipped with a supplementary heater : no
G	Heat pump combination heater : no
H	Parameters shall be declared for medium-temperature application, except for low-temperature heat pumps. For low-temperature heat pump, parameters shall be declared for low-temperature application.
I	Parameters shall be declared for average climate conditions.

	Item <sup>(1)</sup>	Symbol <sup>(2)</sup>	Value <sup>(3)</sup>	Unit <sup>(4)</sup>
N	Rated heat output <sup>(1)</sup>	Prated <sup>(6)</sup>	8	kW
Q	Declared capacity for heating for part load at indoor temperature 20 °C and outdoor temperature Tj			
-	Tj = -7 °C	Pdh	7.1	kW
	Tj = +2 °C	Pdh	4.3	kW
	Tj = +7 °C	Pdh	2.8	kW
	Tj = +12 °C	Pdh	1.2	kW
T	Tj = bivalent temperature	Pdh	8.0	kW
U	Tj = operation limit temperature	Pdh	8.0	kW
V	For air-to-water heat pumps Tj = -15 °C (if TOL < -20 °C)	Pdh	-	kW
W	Bivalent temperature	Tbiv	-10	°C
Y	Cycling interval capacity for heating	Pcyh	-	kW
AB	Degradation co-efficient <sup>(7)</sup>	Cdh	0.9	-
AD	Power consumption in modes other than active mode			
AF	Off mode	Poff	0.080	kW
AG	Thermostat-off mode	Pto	0.011	kW
AH	Standby mode	Psa	0.011	kW
AI	Crankcase heater mode	Pcc	0.000	kW
AK	Other items			
AL	Capacity control		variable <sup>(8A)</sup>	
AP	Sound power level, indoors/ outdoors	Lwa	47/64	dB
AQ	Emissions of nitrogen oxides	NOx	-	mg/kWh
AS	For heat pump combination heater			
AT	Declared load profile		-	
AV	Daily electricity consumption	Qelec	-	kWh
AX	Contact details	http://www.samsung.com		

	Item <sup>(1)</sup>	Symbol <sup>(2)</sup>	Value <sup>(3)</sup>	Unit <sup>(4)</sup>
P	Seasonal space heating energy efficiency	$\eta_p$	112	%
R	Declared coefficient of performance or primary energy ratio for part load at indoor temperature 20 °C and outdoor temperature Tj			
-	Tj = -7 °C	COPd <sup>(5)</sup>	1.77	-
	Tj = +2 °C	COPd <sup>(5)</sup>	2.74	-
	Tj = +7 °C	COPd <sup>(5)</sup>	4.51	-
	Tj = +12 °C	COPd <sup>(5)</sup>	7.02	-
T	Tj = bivalent temperature	COPd <sup>(5)</sup>	1.62	-
U	Tj = operation limit temperature	COPd <sup>(5)</sup>	1.62	-
V	For air-to-water heat pumps Tj = -15 °C (if TOL < -20 °C)	COPd <sup>(5)</sup>	-	-
X	For air-to-water heat pumps: Operation limit temperature	TOL	-10	°C
Z	Cycling interval efficiency	COPcyc <sup>(8A)</sup>	-	-
AC	Heating water operating limit temperature	WTOL	-	°C
AE	Supplementary heater			
N	Rated heat output <sup>(1)</sup>	Psup	-	kW
AJ	Type of energy input			
AK	Other items			
AN	For air-to-water heat pumps : Rated air flow rate, outdoors	-	108	m <sup>3</sup> /h <sup>(6A)</sup>
AR	For water-/brine-to-water heat pumps: Rated brine or water flow rate, outdoor heat exchanger	-	-	m <sup>3</sup> /h <sup>(6A)</sup>
AS	For heat pump combination heater			
AU	Water heating energy efficiency	$\eta_{wh}$	-	%
AW	Daily fuel consumption	Qfuel	-	kWh

AY <sup>(1)</sup> For heat pump space heaters and heat pump combination heaters, the rated that output Prated is equal to the design load for heating Pdesignh, and the rated heat output of a supplementary heater Psup is equal to the supplementary capacity for heating sup(Tj).

AZ <sup>(7)</sup> If Cdh is not determined by measurement then the default degradation coefficient is Cdh = 0.9.

BA <sup>(1)</sup> Precautions as described in the installation/user manual must be taken when assembling, installing and maintaining this product.

BB <sup>(2)</sup> If you are a professional looking for information on non-destructive disassembly and dismantling, please send an email to: erims.sec@samsung.com

# COMMISSION REGULATION (EU) No 813/2013 <sup>1)</sup>

A	Model(s) : AE140JXEDEH/AE160JNYDEH
B	Air-to-water heat pump : yes
C	Water-to-water heat pump : no
D	Brine-to-water heat pump : no
E	Low-temperature heat pump : no
F	Equipped with a supplementary heater : no
G	Heat pump combination heater : no
H	Parameters shall be declared for medium-temperature application, except for low-temperature heat pumps. For low-temperature heat pump, parameters shall be declared for low-temperature application.
I	Parameters shall be declared for average climate conditions.

	Item <sup>(1)</sup>	Symbol <sup>(2)</sup>	Value <sup>(3)</sup>	Unit <sup>(4)</sup>
N	Rated heat output <sup>(1)</sup>	Prated <sup>(6)</sup>	9	kW
Q	Declared capacity for heating for part load at indoor temperature 20 °C and outdoor temperature Tj			
-	Tj = -7 °C	Pdh	7.5	kW
	Tj = +2 °C	Pdh	4.6	kW
	Tj = +7 °C	Pdh	2.9	kW
	Tj = +12 °C	Pdh	1.3	kW
T	Tj = bivalent temperature	Pdh	8.5	kW
U	Tj = operation limit temperature	Pdh	8.5	kW
V	For air-to-water heat pumps Tj = -15 °C (if TOL < -20 °C)	Pdh	-	kW
W	Bivalent temperature	Tbiv	-10	°C
Y	Cycling interval capacity for heating	Pcyc	-	kW
AB	Degradation co-efficient <sup>(7)</sup>	Cdh	0.9	-
AD	Power consumption in modes other than active mode			
AF	Off mode	Poff	0.080	kW
AG	Thermostat-off mode	Ptro	0.011	kW
AH	Standby mode	Psa	0.011	kW
AI	Crankcase heater mode	Pcx	0.000	kW
AK	Other items			
AL	Capacity control		variable <sup>(8A)</sup>	
AP	Sound power level, indoors/ outdoors	Lwa	47/64	dB
AQ	Emissions of nitrogen oxides	NOx	-	mg/kWh
AS	For heat pump combination heater			
AT	Declared load profile		-	
AV	Daily electricity consumption	Qelec	-	kWh
AX	Contact details	http://www.samsung.com		

	Item <sup>(1)</sup>	Symbol <sup>(2)</sup>	Value <sup>(3)</sup>	Unit <sup>(4)</sup>
P	Seasonal space heating energy efficiency	$\eta_p$	110	%
R	Declared coefficient of performance or primary energy ratio for part load at indoor temperature 20 °C and outdoor temperature Tj			
-	Tj = -7 °C	COPd <sup>(5)</sup>	1.83	-
	Tj = +2 °C	COPd <sup>(5)</sup>	2.33	-
	Tj = +7 °C	COPd <sup>(5)</sup>	4.47	-
	Tj = +12 °C	COPd <sup>(5)</sup>	6.94	-
T	Tj = bivalent temperature	COPd <sup>(5)</sup>	1.63	-
U	Tj = operation limit temperature	COPd <sup>(5)</sup>	1.63	-
V	For air-to-water heat pumps Tj = -15 °C (if TOL < -20 °C)	COPd <sup>(5)</sup>	-	-
X	For air-to-water heat pumps: Operation limit temperature	TOL	-10	°C
Z	Cycling interval efficiency	COPcyc <sup>(6A)</sup>	-	-
AC	Heating water operating limit temperature	WTOL	-	°C
AE	Supplementary heater			
N	Rated heat output <sup>(1)</sup>	Psup	-	kW
AJ	Type of energy input			
AK	Other items			
AN	For air-to-water heat pumps : Rated air flow rate, outdoors	-	108	m <sup>3</sup> /h <sup>(8A)</sup>
AR	For water-/brine-to-water heat pumps: Rated brine or water flow rate, outdoor heat exchanger	-	-	m <sup>3</sup> /h <sup>(8A)</sup>
AS	For heat pump combination heater			
AJ	Water heating energy efficiency	$\eta_{wh}$	-	%
AW	Daily fuel consumption	Qfuel	-	kWh

AY <sup>(7)</sup> For heat pump space heaters and heat pump combination heaters, the rated that output Prated is equal to the design load for heating Pdesignh, and the rated heat output of a supplementary heater Psup is equal to the supplementary capacity for heating sup(Tj).

AZ <sup>(7A)</sup> If Cdh is not determined by measurement then the default degradation coefficient is Cdh = 0.9.

BA <sup>(1)</sup> Precautions as described in the installation/user manual must be taken when assembling, installing and maintaining this product.

BB <sup>(2)</sup> If you are a professional looking for information on non-destructive disassembly and dismantling, please send an email to: erims.sec@samsung.com

A	Model(s) : AE140JXEDGH/AE160JNYDGH
B	Air-to-water heat pump : yes
C	Water-to-water heat pump : no
D	Brine-to-water heat pump : no
E	Low-temperature heat pump : no
F	Equipped with a supplementary heater : no
G	Heat pump combination heater : no
H	Parameters shall be declared for medium-temperature application, except for low-temperature heat pumps. For low-temperature heat pump, parameters shall be declared for low-temperature application.
I	Parameters shall be declared for average climate conditions.

	Item <sup>(1)</sup>	Symbol <sup>(2)</sup>	Value <sup>(3)</sup>	Unit <sup>(4)</sup>
N	Rated heat output <sup>(1)</sup>	Prated <sup>(6)</sup>	9	kW
Q	Declared capacity for heating for part load at indoor temperature 20 °C and outdoor temperature Tj			
-	Tj = -7 °C	Pdh	7.5	kW
	Tj = +2 °C	Pdh	4.6	kW
	Tj = +7 °C	Pdh	2.9	kW
	Tj = +12 °C	Pdh	1.3	kW
T	Tj = bivalent temperature	Pdh	8.5	kW
U	Tj = operation limit temperature	Pdh	8.5	kW
V	For air-to-water heat pumps Tj = -15 °C (if TOL < -20 °C)	Pdh	-	kW
W	Bivalent temperature	Tbiv	-10	°C
Y	Cycling interval capacity for heating	Pcyh	-	kW
AB	Degradation co-efficient <sup>(7)</sup>	Cdh	0.9	-
AD	Power consumption in modes other than active mode			
AF	Off mode	Poff	0.080	kW
AG	Thermostat-off mode	Pto	0.011	kW
AH	Standby mode	Psa	0.011	kW
AI	Crankcase heater mode	Pcc	0.000	kW
AK	Other items			
AL	Capacity control		variable <sup>(8A)</sup>	
AP	Sound power level, indoors/ outdoors	Lwa	47/64	dB
AQ	Emissions of nitrogen oxides	NOx	-	mg/kWh
AS	For heat pump combination heater			
AT	Declared load profile		-	
AV	Daily electricity consumption	Qelec	-	kWh
AX	Contact details	http://www.samsung.com		

	Item <sup>(1)</sup>	Symbol <sup>(2)</sup>	Value <sup>(3)</sup>	Unit <sup>(4)</sup>
P	Seasonal space heating energy efficiency	$\eta_p$	110	%
R	Declared coefficient of performance or primary energy ratio for part load at indoor temperature 20 °C and outdoor temperature Tj			
-	Tj = -7 °C	COPd <sup>(5)</sup>	1.83	-
	Tj = +2 °C	COPd <sup>(5)</sup>	2.33	-
	Tj = +7 °C	COPd <sup>(5)</sup>	4.47	-
	Tj = +12 °C	COPd <sup>(5)</sup>	6.94	-
T	Tj = bivalent temperature	COPd <sup>(5)</sup>	1.63	-
U	Tj = operation limit temperature	COPd <sup>(5)</sup>	1.63	-
V	For air-to-water heat pumps Tj = -15 °C (if TOL < -20 °C)	COPd <sup>(5)</sup>	-	-
X	For air-to-water heat pumps: Operation limit temperature	TOL	-10	°C
Z	Cycling interval efficiency	COPcyc <sup>(8A)</sup>	-	-
AC	Heating water operating limit temperature	WTOL	-	°C
AE	Supplementary heater			
N	Rated heat output <sup>(1)</sup>	Psup	-	kW
AJ	Type of energy input			
AK	Other items			
AN	For air-to-water heat pumps : Rated air flow rate, outdoors	-	108	m <sup>3</sup> /h <sup>(6A)</sup>
AR	For water-/brine-to-water heat pumps: Rated brine or water flow rate, outdoor heat exchanger	-	-	m <sup>3</sup> /h <sup>(6A)</sup>
AS	For heat pump combination heater			
AU	Water heating energy efficiency	$\eta_{wh}$	-	%
AW	Daily fuel consumption	Qfuel	-	kWh

AY <sup>(1)</sup> For heat pump space heaters and heat pump combination heaters, the rated that output Prated is equal to the design load for heating Pdesignh, and the rated heat output of a supplementary heater Psup is equal to the supplementary capacity for heating sup(Tj).

AZ <sup>(7)</sup> If Cdh is not determined by measurement then the default degradation coefficient is Cdh = 0.9.

BA <sup>(1)</sup> Precautions as described in the installation/user manual must be taken when assembling, installing and maintaining this product.

BB <sup>(2)</sup> If you are a professional looking for information on non-destructive disassembly and dismantling, please send an email to: erims.sec@samsung.com

# COMMISSION REGULATION (EU) No 813/2013<sup>1)</sup>

A	Model(s) : AE160JXEDEH/AE160JNYDEH
B	Air-to-water heat pump : yes
C	Water-to-water heat pump : no
D	Brine-to-water heat pump : no
E	Low-temperature heat pump : no
F	Equipped with a supplementary heater : no
G	Heat pump combination heater : no
H	Parameters shall be declared for medium-temperature application, except for low-temperature heat pumps. For low-temperature heat pump, parameters shall be declared for low-temperature application.
I	Parameters shall be declared for average climate conditions.

	Item <sup>(1)</sup>	Symbol <sup>(2)</sup>	Value <sup>(3)</sup>	Unit <sup>(4)</sup>
N	Rated heat output <sup>(1)</sup>	Prated <sup>(6)</sup>	10	kW
Q	Declared capacity for heating for part load at indoor temperature 20 °C and outdoor temperature Tj			
-	Tj = -7 °C	Pdh	8.4	kW
	Tj = +2 °C	Pdh	5.1	kW
	Tj = +7 °C	Pdh	3.3	kW
	Tj = +12 °C	Pdh	1.5	kW
T	Tj = bivalent temperature	Pdh	9.5	kW
U	Tj = operation limit temperature	Pdh	9.5	kW
V	For air-to-water heat pumps Tj = -15 °C (if TOL < -20 °C)	Pdh	-	kW
W	Bivalent temperature	Tbiv	-10	°C
Y	Cycling interval capacity for heating	Pcyc	-	kW
AB	Degradation co-efficient <sup>(7)</sup>	Cdh	0.9	-
AD	Power consumption in modes other than active mode			
AF	Off mode	Poff	0.080	kW
AG	Thermostat-off mode	Ptro	0.011	kW
AH	Standby mode	Psa	0.011	kW
AI	Crankcase heater mode	Pcx	0.000	kW
AK	Other items			
AL	Capacity control		variable <sup>(8A)</sup>	
AP	Sound power level, indoors/ outdoors	Lwa	47/66	dB
AQ	Emissions of nitrogen oxides	NOx	-	mg/kWh
AS	For heat pump combination heater			
AT	Declared load profile		-	
AV	Daily electricity consumption	Qelec	-	kWh
AX	Contact details	http://www.samsung.com		

	Item <sup>(1)</sup>	Symbol <sup>(2)</sup>	Value <sup>(3)</sup>	Unit <sup>(4)</sup>
P	Seasonal space heating energy efficiency	$\eta_p$	108	%
R	Declared coefficient of performance or primary energy ratio for part load at indoor temperature 20 °C and outdoor temperature Tj			
-	Tj = -7 °C	COPd <sup>(5)</sup>	1.83	-
	Tj = +2 °C	COPd <sup>(5)</sup>	2.37	-
	Tj = +7 °C	COPd <sup>(5)</sup>	3.84	-
	Tj = +12 °C	COPd <sup>(5)</sup>	6.94	-
T	Tj = bivalent temperature	COPd <sup>(5)</sup>	1.63	-
U	Tj = operation limit temperature	COPd <sup>(5)</sup>	1.63	-
V	For air-to-water heat pumps Tj = -15 °C (if TOL < -20 °C)	COPd <sup>(5)</sup>	-	-
X	For air-to-water heat pumps: Operation limit temperature	TOL	-10	°C
Z	Cycling interval efficiency	COPcyc <sup>(8A)</sup>	-	-
AC	Heating water operating limit temperature	WTOL	-	°C
AE	Supplementary heater			
N	Rated heat output <sup>(1)</sup>	Psup	-	kW
AJ	Type of energy input			
AK	Other items			
AN	For air-to-water heat pumps : Rated air flow rate, outdoors	-	108	m <sup>3</sup> /h <sup>(8A)</sup>
AR	For water-/brine-to-water heat pumps: Rated brine or water flow rate, outdoor heat exchanger	-	-	m <sup>3</sup> /h <sup>(8A)</sup>
AS	For heat pump combination heater			
AJ	Water heating energy efficiency	$\eta_{wh}$	-	%
AW	Daily fuel consumption	Qfuel	-	kWh

AY <sup>(1)</sup> For heat pump space heaters and heat pump combination heaters, the rated that output Prated is equal to the design load for heating Pdesignh, and the rated heat output of a supplementary heater Psup is equal to the supplementary capacity for heating sup(Tj).

AZ <sup>(7)</sup> If Cdh is not determined by measurement then the default degradation coefficient is Cdh = 0.9.

BA <sup>(1)</sup> Precautions as described in the installation/user manual must be taken when assembling, installing and maintaining this product.

BB <sup>(2)</sup> If you are a professional looking for information on non-destructive disassembly and dismantling, please send an email to: erims.sec@samsung.com

A	Model(s) : AE160JXEDGH/AE160JNYDGH
B	Air-to-water heat pump : yes
C	Water-to-water heat pump : no
D	Brine-to-water heat pump : no
E	Low-temperature heat pump : no
F	Equipped with a supplementary heater : no
G	Heat pump combination heater : no
H	Parameters shall be declared for medium-temperature application, except for low-temperature heat pumps. For low-temperature heat pump, parameters shall be declared for low-temperature application.
I	Parameters shall be declared for average climate conditions.

	Item <sup>(1)</sup>	Symbol <sup>(2)</sup>	Value <sup>(3)</sup>	Unit <sup>(4)</sup>
N	Rated heat output <sup>(1)</sup>	Prated <sup>(6)</sup>	10	kW
Q	Declared capacity for heating for part load at indoor temperature 20 °C and outdoor temperature Tj			
-	Tj = -7 °C	Pdh	8.4	kW
	Tj = +2 °C	Pdh	5.1	kW
	Tj = +7 °C	Pdh	3.3	kW
	Tj = +12 °C	Pdh	1.5	kW
T	Tj = bivalent temperature	Pdh	9.5	kW
U	Tj = operation limit temperature	Pdh	9.5	kW
V	For air-to-water heat pumps Tj = -15 °C (if TOL < -20 °C)	Pdh	-	kW
W	Bivalent temperature	Tbiv	-10	°C
Y	Cycling interval capacity for heating	Pcyh	-	kW
AB	Degradation co-efficient <sup>(7)</sup>	Cdh	0.9	-
AD	Power consumption in modes other than active mode			
AF	Off mode	Poff	0.080	kW
AG	Thermostat-off mode	Pto	0.011	kW
AH	Standby mode	Psa	0.011	kW
AI	Crankcase heater mode	Pcc	0.000	kW
AK	Other items			
AL	Capacity control		variable <sup>(8A)</sup>	
AP	Sound power level, indoors/ outdoors	Lwa	47/69	dB
AQ	Emissions of nitrogen oxides	NOx	-	mg/kWh
AS	For heat pump combination heater			
AT	Declared load profile		-	
AV	Daily electricity consumption	Qelec	-	kWh
AX	Contact details	http://www.samsung.com		

	Item <sup>(1)</sup>	Symbol <sup>(2)</sup>	Value <sup>(3)</sup>	Unit <sup>(4)</sup>
P	Seasonal space heating energy efficiency	$\eta_p$	108	%
R	Declared coefficient of performance or primary energy ratio for part load at indoor temperature 20 °C and outdoor temperature Tj			
-	Tj = -7 °C	COPd <sup>(5)</sup>	1.83	-
	Tj = +2 °C	COPd <sup>(5)</sup>	2.37	-
	Tj = +7 °C	COPd <sup>(5)</sup>	3.84	-
	Tj = +12 °C	COPd <sup>(5)</sup>	6.94	-
T	Tj = bivalent temperature	COPd <sup>(5)</sup>	1.63	-
U	Tj = operation limit temperature	COPd <sup>(5)</sup>	1.63	-
V	For air-to-water heat pumps Tj = -15 °C (if TOL < -20 °C)	COPd <sup>(5)</sup>	-	-
X	For air-to-water heat pumps: Operation limit temperature	TOL	-10	°C
Z	Cycling interval efficiency	COPcyc <sup>(8A)</sup>	-	-
AC	Heating water operating limit temperature	WTOL	-	°C
AE	Supplementary heater			
N	Rated heat output <sup>(1)</sup>	Psup	-	kW
AJ	Type of energy input			
AK	Other items			
AN	For air-to-water heat pumps : Rated air flow rate, outdoors	-	108	m <sup>3</sup> /h <sup>(6A)</sup>
AR	For water-/brine-to-water heat pumps: Rated brine or water flow rate, outdoor heat exchanger	-	-	m <sup>3</sup> /h <sup>(6A)</sup>
AS	For heat pump combination heater			
AU	Water heating energy efficiency	$\eta_{wh}$	-	%
AW	Daily fuel consumption	Qfuel	-	kWh

AY <sup>(1)</sup> For heat pump space heaters and heat pump combination heaters, the rated that output Prated is equal to the design load for heating Pdesignh, and the rated heat output of a supplementary heater Psup is equal to the supplementary capacity for heating sup(Tj).

AZ <sup>(7)</sup> If Cdh is not determined by measurement then the default degradation coefficient is Cdh = 0.9.

BA <sup>(1)</sup> Precautions as described in the installation/user manual must be taken when assembling, installing and maintaining this product.

BB <sup>(2)</sup> If you are a professional looking for information on non-destructive disassembly and dismantling, please send an email to: erims.sec@samsung.com

# COMMISSION REGULATION (EU) No 813/2013 <sup>1)</sup>

No	English(EN)	Bulgarian(BG)	Spanish(ES)	Czech(CS)
I	COMMISSION REGULATION (EU) No 813/2013	РЕГЛАМЕНТ (ЕС) № 813/2013 НА КОМИСИЯТА	REGlamento (UE) No 813/2013 DE LA COMISIÓN	NAŘÍZENÍ KOMISE (EU) č. 813/2013
II	ECODESIGN REQUIREMENTS FOR SPACE HEATER	Изискванията за екопроектиране на отоплителен топлоизточник	Los requisitos de diseño ecológico de aparato de calefacción	Požadavky na ekodesign pro vytápění vnitřních prostorů
A	Model(s); [information identifying the model(s) to which the information relates]	Модел/модел; [информация за определяне на модела(ите), за който(ито) тя се отнася]	Modelos; [Datos que identifican el modelo o modelos a los que se refiere la información]	Model/y; [informace pro určitý modelu/ů, na který/ě se informace vztahují]
B	Air-to-water heat pump; [yes/no]	Термопомпа „въздух-вода“; [да/не]	Bomba de calor aire-agua; [sí/no]	Teplné čerpadlo vzduch-voda; [ano/ne]
C	Water-to-water heat pump; [yes/no]	Термопомпа „вода-вода“; [да/не]	Bomba de calor agua-agua; [sí/no]	Teplné čerpadlo voda-voda; [ano/ne]
D	Brine-to-water heat pump; [yes/no]	Термопомпа „солон разтвор-вода“; [да/не]	Bomba de calor salmuera-agua; [sí/no]	Teplné čerpadlo solanka-voda; [ano/ne]
E	Low-temperature heat pump; [yes/no]	Термопомпа за нискотемпературни приложения; [да/не]	Bomba de calor de baja temperatura; [sí/no]	Nízkooteplňovací teplné čerpadlo; [ano/ne]
F	Equipped with a supplementary heater; [yes/no]	Оборудвана с допълнителен подгревател; [да/не]	Equipado con un calefactor complementario; [sí/no]	Vybavenost přídavným ohřívačem; [ano/ne]
G	Heat pump combination heater; [yes/no]	Комбиниран термопомпен апарат за отопление и БГВ; [да/не]	Calefactor combinado con bomba de calor; [sí/no]	Kombinovaný ohřívač s teplem čerpadlem; [ano/ne]
H	Parameters shall be declared for medium-temperature application, except for low-temperature heat pumps. For low-temperature heat pumps, parameters shall be declared for low-temperature application.	Параметрите се обявяват за среднотемпературни приложения, освен при термопомпите с нискотемпературни приложения. При термопомпите с нискотемпературни приложения параметрите се обявяват за нискотемпературните приложения.	Los parámetros se declararán para aplicaciones de media temperatura, excepto si se trata de bombas de calor de baja temperatura. En el caso de las bombas de calor de baja temperatura, los parámetros se declararán para aplicaciones de baja temperatura.	Parametry musí být uvedeny pro středněteplotní aplikaci, s výjimkou nízkoteplotních teplených čerpadel. U nízkoteplotních teplených čerpadel musí být parametry uvedeny pro nízkoteplotní aplikaci.
I	Parameters shall be declared for average climate conditions.	Параметрите се обявяват за средни климатични условия.	Los parámetros se indicarán para condiciones climáticas medias.	Parametry musí být uvedeny pro průměrné klimatické podmínky.
J	Item	Характеристика	Elemento	Položka
K	Symbol	Означение	Símbolo	Označení
L	Value	Стойност	Valor	Hodnota
M	Unit	Мерна единица	Unidad	Jednotka
N	Rated heat output(*)	Номинална топлинна мощност(*)	Potencia calorífica nominal (*)	Jmenovitý tepelný výkon (*)
O	Prated	Prated	Prated	Prated
P	Seasonal space heating energy efficiency	Сезонна енергийна ефективност при отопление	Eficiencia energética estacional de calefacción	Sezónní energetická účinnost vytápění
Q	Declared capacity for heating for part load at indoor temperature 20 °C and outdoor temperature Tj	Обявена отоплителна мощност за частичен товар при температура вътре 20 °C и външна температура Tj	Capacidad de calefacción declarada para una carga parcial a una temperatura interior de 20 °C y una temperatura exterior Tj	Deklarovaný topný výkon pro částečné zatížení při vnitřní teplotě 20 °C a venkovní teplotě Tj
R	Declared coefficient of performance or primary energy ratio for part load at indoor temperature 20 °C and outdoor temperature Tj	Обявен коефициент на трансформация или коефициент на първичната енергия за частичен товар при температура вътре 20 °C и външна температура Tj	Coefficiente de rendimiento declarado o factor energético primario para una carga parcial a una temperatura interior de 20 °C y una temperatura exterior Tj	Deklarovaný topný faktor či koeficient primární energie pro částečné zatížení při vnitřní teplotě 20 °C a venkovní teplotě Tj
S	COPd or PERd	COPd или PERd	COPd o PERd	COPd nebo PERd
T	Tj = bivalent temperature	Tj = температура на включване на допълнително подгреване	Tj = temperatura bivalente	Tj = bivalentní teplota
U	Tj = operation limit temperature	Tj = гранична работна температура	Tj = temperatura límite de funcionamiento	Tj = mezní provozní teplota
V	For air-to-water heat pumps: Tj = -15 °C (if TOL < -20 °C)	За термопомпи „въздух-вода“: Tj = -15 °C (ако TOL < -20 °C)	Para bombas de calor aire-agua: Tj = -15 °C (si TOL < -20 °C)	U teplených čerpadel vzduch-voda: Tj = -15 °C (pokud TOL < -20 °C)
W	Bivalent temperature	Температура на включване на допълнително подгреване	Temperatura bivalente	Bivalentní teplota
X	For air-to-water heat pumps: Operation limit temperature	За термопомпи „въздух-вода“: гранична работна температура	Para bombas de calor aire-agua: Temperatura límite de funcionamiento	U teplených čerpadel vzduch-voda: mezní provozní teplota
Y	Cycling interval capacity for heating	Мощност при повторно-кратковременен режим на отопление	Eficiencia del intervalo cíclico para calefacción	Topný výkon v cyklickém intervalu
Z	Cycling interval efficiency	Ефективност при повторно-кратковременен режим	Eficiencia del intervalo cíclico	Účinnost v cyklickém intervalu
AA	COPcyc or PERcyc	COPcyc или PERcyc	COPcyc o PERcyc	COPcyc nebo PERcyc
AB	Degradation co-efficient(**)	Коефициент на влошаване на ефективността(**)	Coefficiente de degradación (**)	Koeficient ztráty energie (**)
AC	Heating water operating limit temperature	Гранична температура на загряваната вода	Temperatura límite de calentamiento de agua	Mezní provozní teplota ohříváné vody

No	English(EN)	Bulgarian(BG)	Spanish(ES)	Czech(CS)
AD	Power consumption in modes other than active mode	Консумирана мощност в режими, различни от работен режим	Consumo de electricidad en modos distintos del activo	Spotřeba elektrické energie v jiných režimech než aktivní režim
AE	Supplementary heater	Допълнителен подгревател	Calefactor complementario	Přídavný ohřívač
AF	Off mode	Режим „изключен“	Modo desactivado	Vypnutý stav
AG	Thermostat-off mode	Режим „термостатно изключен“	Modo desactivado por termostato	Stav vypnutého termostatu
AH	Standby mode	Режим „в готовност“	Modo de espera	Pohotovostní režim
AI	Crankcase heater mode	Режим „подгреване на картера на компресора“	Modo de calentador del cárter	Režim zahřívání skříně kompresoru
AJ	Type of energy input	Вид на постъпващата енергия	Tipo de insumo de energía	Energetický příkon
AK	Other items	Други характеристики	Otros elementos	Jiné položky
AL	Capacity control	Регулиране на мощността	Control de capacidad	Regulace výkonu
AM	fixed/variable	фиксирана/регулируема	fijo/variable	pevná/proměnná
AN	For air-to-water heat pumps: Rated air flow rate, outdoors	За термомпомпи „въздух-вода“: номинален дебит на въздуха (на открито)	Para bombas de calor aire-agua: Caudal de aire nominal (exterior)	U tepelných čerpadel vzduch-voda: jmenovitý průtok vzduchu ve venkovním prostoru
AO	m <sup>3</sup> /h	m <sup>3</sup> /h	m <sup>3</sup> /h	m <sup>3</sup> /h
AP	Sound power level, indoors/outdoors	Ниво на шума (вътрешно/на открито)	Nivel de potencia acústica (interior/exterior)	Hladina akustického výkonu ve vnitřním prostoru/venkovním prostoru
AQ	Emissions of nitrogen oxides	Емисии на азотни окиси	Emisiones de óxidos de nitrógeno	Emise oxidů dusku
AR	For water-/brine-to-water heat pumps: Rated brine or water flow rate, outdoor heat exchanger	За термомпомпи „вода/солов разтвор-вода“: номинален дебит на соловия разтвор, или водата, външен топлообменник	Para bombas de calor agua/salmuera a agua: Caudal de salmuera o de agua nominal, intercambiador de calor de exterior	U tepelných čerpadel voda-voda/solanka-voda: jmenovitý průtok solanky nebo vody, venkovní výměník tepla
AS	For heat pump combination heater:	За комбиниран термомпомен агрегат за отопление и БГ В.	Para calefactores combinados con bomba de calor:	U kombinovaného ohřívače s tepelným čerpadlem:
AT	Declared load profile	Обявен товаров профил	Perfil de carga declarado	Deklarovaný zátěžový profil
AU	Water heating energy efficiency	Енергийна ефективност при подгреване на вода	Eficiencia energética de caldeo de agua	Energetická účinnost ohřevu vody
AV	Daily electricity consumption	Дневно електропотребление	Consumo diario de electricidad	Denní spotřeba elektrické energie
AW	Daily fuel consumption	Дневно потребление на гориво	Consumo diario de combustible	Denní spotřeba paliva
AX	Contact details	Координати за връзка	Datos de contacto	Kontaktní údaje
AY	(*) For heat pump space heaters and heat pump combination heaters, the rated that output Prated is equal to the design load for heating Pdesign, and the rated heat output of a supplementary heater Psup is equal to the supplementary capacity for heating sup(Tj).	(*) За отоплителни термомпоменни агрегати и комбинирани термомпоменни агрегати, номиналната топлинна мощност Prated е равна на проекцията отоплителен товар Pdesign, а номиналната топлинна мощност на допълнителния подгревател Psup е равна на допълнителната отоплителна мощност sup(Tj)	(*) Para los aparatos de calefacción con bomba de calor y calefactores combinados con bomba de calor, la potencia calorífica nominal Prated es igual a la carga de calefacción de diseño Pdesign, y la potencia calorífica nominal de un calefactor complementario Psup es igual a la capacidad complementaria de calefacción sup(Tj).	(*) U ohřívačů pro vytápění vnitřních prostorů s tepelným čerpadlem a kombinovaných ohřívačů s tepelným čerpadlem je jmenovitý tepelný výkon Prated roven návrhovému topnému zatížení Pdesign a jmenovitý tepelný výkon přídavného ohřívače Psup je roven doplňkovému topnému výkonu sup(Tj).
AZ	(**) If Cdh is not determined by measurement then the default degradation coefficient is Cdh = 0.9.	(**) Ако Cdh не е определен чрез измерване, съответната ориентировъчно приемана стойност за коефициента на влошаване на ефективността е Cdh = 0.9.	(**) Si no se determina Cdh por medición, el coeficiente de degradación predeterminado será Cdh = 0.9.	(**) Není-li koeficient ztráty energie Cdh stanoven měřením, má implicitní hodnotu 0.9.
BA	1) Precautions as described in the installation/user manual must be taken when assembling, installing and maintaining this product.	1) Описаните в ръководството за монтиране/ръководството за потребителя предпазни мерки трябва да се спазват при събиране, монтиране и поддръжка на продукта.	1) Deben tomarse las precauciones que se indican en el manual de instalación/usuario al montar e instalar el producto, así como al realizar tareas de mantenimiento.	1) Při montáži, instalaci a údržbě tohoto produktu je třeba se řídit bezpečnostními opatřeními popsanými v instalační a uživatelské příručce.
BB	2) If you are a professional looking for information on non-destructive disassembly and dismantling, please send an email to: erims.sec@samsung.com	2) Ако сте професионалист и търсите информация относно възможностите за неразрушително разглобяване и демонтаж, моля, изпратете имейл на адрес: erims.sec@samsung.com	2) Si Usted es un profesional que desea obtener información sobre el desmontaje y desmantelamiento no destructivo de este producto, por favor, diríjase a la siguiente dirección de correo electrónico: erims.sec@samsung.com	2) Pokud jste odborným pracovníkem a hledáte informace ohledně bezpečné demontáže produktu, napište e-mail na adresu: erims.sec@samsung.com.

# COMMISSION REGULATION (EU) No 813/2013 <sup>1)</sup>

No	Danish(DA)	German(DE)	Estonian(ET)	Greek(EL)
I	KOMMISSIONENS FORORDNING (EU) Nr. 813/2013	VERORDNUNG (EU) Nr. 813/2013 DER KOMMISSION	KOMISJIONI MÄÄRUS (EL) nr 813/2013,	ΚΑΝΟΝΙΣΜΟΣ (ΕΕ) αριθ. 813/2013 ΤΗΣ ΕΠΙΤΡΟΠΗΣ
II	Kravene til miljøvenligt design af anlæg til rumopvarmning	Die Ökodesign-Anforderungen an Raumheizgerät	Ökodsaini nõuded ruumi kütmiseks	Οι απαιτήσεις οικολογικού σχεδιασμού για θερμαντήρας χώρου
A	Model(ler); [Information, som identificerer den eller de modeller, som oplysningerne vedrører]	Modell(e); [Angaben zur Bestimmung des Modells/der Modelle, auf das/die sich die Angaben beziehen]	Mudel(d); [mudelit (mudeleid) iseloomustavad näitajad]	Μοντέλο(-α); [Πληροφορίες για την ταυτοποίηση του μοντέλου (των μοντέλων) που αφορούν οι πληροφορίες]
B	Luft-vand-varmepumpe: [ja/nej]	Luft-Wasser-Wärmepumpe: (Ja/Nein)	Õhu-vee-soojuspump: [jah/ei]	Αντλία θερμότητας αέρα-νερού: [ναι/όχι]
C	Vand-vand-varmepumpe: [ja/nej]	Wasser-Wasser-Wärmepumpe: (Ja/Nein)	Vee-vee-soojuspump: [jah/ei]	Αντλία θερμότητας νερού-νερού: [ναι/όχι]
D	Brine-vand-varmepumpe: [ja/nej]	Sole-Wasser-Wärmepumpe: (Ja/Nein)	Soojuskanjaja-vee-soojuspump: [jah/ei]	Αντλία θερμότητας άλμυρ-νερού: [ναι/όχι]
E	Lavtemperaturvarmepumpe: [ja/nej]	Niedertemperatur-Wärmepumpe: (Ja/Nein)	Külma kliima soojuspump: [jah/ei]	Αντλία θερμότητας χαμηλής θερμοκρασίας: [ναι/όχι]
F	Udstyret med supplerende forsyningsanlæg: [ja/nej]	Mit Zusatzheizgerät: (Ja/Nein)	Koos lisakütteseadmega: [jah/ei]	Εξοπλισμένος με συμπληρωματικό θερμαντήρα: [ναι/όχι]
G	Varmepumpeanlæg til kombineret rum- og brugsvandsopvarmning: [ja/nej]	Kombiheizgerät mit Wärmepumpe: (Ja/Nein)	Soojuspumbaga veesoojendi-küttesead: [jah/ei]	Θερμαντήρας συνδυασμένης λειτουργίας με αντλία θερμότητας: [ναι/όχι]
H	Parametre skal angives for middeltemperatranvendelse, dog ikke for lavtemperaturvarmepumper. For lavtemperaturvarmepumper angives parametre for lavtemperatranvendelse.	Die Parameter sind für eine Mitteltemperatranwendung anzugeben, außer für Niedertemperatur-Wärmepumpen. Für Niedertemperatur-Wärmepumpen sind die Parameter für eine Niedertemperatranwendung anzugeben.	Näitajad esitatakse keskmise temperatuuriga kasutuse kohta, välja arvatud külma kliima soojuspumbad. Külma kliima soojuspumbade näitajad esitatakse madaltemperatuurilise kasutuse kohta.	Δηλώνονται οι παράμετροι για εφαρμογή μέσης θερμοκρασίας, εξαιρουμένων των αντλιών θερμότητας χαμηλής θερμοκρασίας. Για τις αντλίες θερμότητας χαμηλής θερμοκρασίας δηλώνονται οι παράμετροι για εφαρμογή χαμηλής θερμοκρασίας.
I	Parametre skal angives for gennemsnitlige klimaforhold.	Die Parameter sind für durchschnittliche Klimaverhältnisse anzugeben:	Näitajad esitatakse keskmiste kliimatingimuste kohta.	Δηλώνονται οι παράμετροι για μέσες κλιματικές συνθήκες
J	Element	Angabe	Näitaja	Χαρακτηριστικό
K	Symbol	Symbol	Tähis	Σύμβολο
L	Værdi	Wert	Väärtus	Τιμή
M	Enhed	Einheit	Ühik	Μονάδα
N	Nominalnytteeffekt (*)	Wärmenennleistung (3)	Nimisoojusvõimsus (*)	Ονομαστική θερμική ισχύς (*)
O	Prated	Prated	Prated	Prated
P	Årsvirkningsgrad ved rumopvarmning	Jahreszeitbedingte Raumheizungs-Energieeffizienz	Kütmise sesoonne energiatõhusus	Ενεργειακή απόδοση της εποχιακής θέρμανσης χώρου
Q	Angivet varmeydelse for delast ved indetemperatur på 20 °C og udetemperatur på Tj	Angegebene Leistung für Teilast bei Raumlufttemperatur 20 °C und Außenlufttemperatur Tj	Esitatud soojusvõimsus ruumtemperatuuril 20 °C ja välitemperatuuril Tj vastaval (osalise koormuse) võimsustarbel	Δηλωμένη θερμική ισχύς για μερικό φορτίο σε θερμοκρασία εσωτερικού χώρου 20 °C και θερμοκρασία εξωτερικού χώρου Tj
R	Angivet effektfaktor eller primærenergieffektfaktor for delast ved indetemperatur på 20 °C og udetemperatur på Tj	Angegebene Leistungszahl oder Heizzahl für Teilast bei Raumlufttemperatur 20 °C und Außenlufttemperatur Tj	Esitatud soojusegur (primaarenergiegur) ruumtemperatuuril 20 °C ja välitemperatuuril Tj vastaval (osalise koormuse) võimsustarbel	Δηλωμένος συντελεστής απόδοσης ή λόγος πρωτογενούς ενέργειας σε θερμοκρασία εσωτερικού χώρου 20 °C και θερμοκρασία εξωτερικού χώρου Tj
S	COPd eller PERd	COPd oder PERd	COPd või PERd	COPd ή PERd
T	Tj = bivalenttemperatur	Tj = Bivalenttemperatur	Tj = tasakaaltemperatuur	Tj = δίτιμη θερμοκρασία
U	Tj = temperaturgrense for drift	Tj = Betriebstemperaturgrenzwert	Tj = piirtõotemperatuur	Tj = οριακή θερμοκρασία λειτουργίας
V	For luft-vand-varmepumper: Tj = -15 °C (hvis TOL < -20 °C)	Für Luft-Wasser-Wärmepumpen: Tj = -15 °C (wenn TOL < -20 °C)	Õhu-vee-soojuspump: Tj = -15 °C (kui TOL < -20 °C)	Για αντλίες θερμότητας αέρα-νερού: Tj = -15 °C (εάν TOL < -20 °C)
W	Bivalenttemperatur	Bivalenztemperatur	Tasakaaltemperatuur	Δίτιμη θερμοκρασία
X	For luft-vand-varmepumper: Temperaturgrense for drift	Für Luft-Wasser-Wärmepumpen: Betriebsgrenzwert-Temperatur	Õhu-vee-soojuspump: piirtõotemperatuur	Για αντλίες θερμότητας αέρα-νερού: Οριακή θερμοκρασία λειτουργίας
Y	Cyklusintervaldyldelse for opvarmning	Leistung bei zyklischem Intervall-Heizbetrieb	Tsükli soojusvõimsus	Θερμαντική ισχύς κατά τη διάρκεια ενός κύκλου
Z	Cyklusintervaldyldelse	Leistungszahl bei zyklischem Intervallbetrieb	Tsükli tõhusus või primaarenergiegur	Απόδοση κατά τη διάρκεια ενός κύκλου
AA	COPcyc eller PERcyc	COPcyc oder PERcyc	COPcyc või PERcyc	COPcyc ή PERcyc
AB	Koefficient for effektivitetstab (**)	Minderungsfaktor (4)	Kaotegur (**)	Συντελεστής υποβάθμισης (**)
AC	Temperaturgrense for vandopvarmning	Grenzwert der Betriebstemperatur des Heizwassers	Küttevee piirtõotemperatuur	Οριακή θερμοκρασία λειτουργίας για θέρμανση νερού
AD	Elforbrug i andre tilstande end aktiv tilstand	Stromverbrauch in anderen Betriebsarten als dem Betriebszustand	Võimsustarve ajal, kui seade ei ole aktiivses seisundis	Κατανάλωση ισχύος σε καταστάσεις πλην της ενεργού κατάστασης
AE	Supplerende forsyningsanlæg	Zusatzheizgerät	Lisaküttesead	Συμπληρωματικός θερμαντήρας



No	Danish(DA)	German(DE)	Estonian(ET)	Greek(EL)
AF	Slukket tilstand	Aus-Zustand	Väljalülitatud seisund	Κατάσταση εκτός λειτουργίας
AG	Termostat fra-tilstand	Thermostat-aus-Zustand	Termostaadajaga välja lülitatud seisund	Κατάσταση χωρίς λειτουργία θερμοστάτη
AH	Standbytilstand	Bereitschaftszustand	Ooteseisund	Κατάσταση αναμονής
AI	Krumtaphusopvarmningsstilstand	Betriebszustand mit Kurbelgehäuseheizung	Kambrikütte seisund	Λειτουργία θερμαντήρα στροφαλοθαλάμου
AJ	Energiinputtype	Art der Energiezufuhr	Sisendenergia liik	Τύπος εισερχόμενης ενέργειας
AK	Andre elementer	Sonstige Angaben	Muud näitajad	Άλλα χαρακτηριστικά
AL	Ydelsesregulering	Leistungssteuerung	Võimsuse reguleerimine	Ρύθμιση ισχύος
AM	fast/variabel	fest/veränderlich	Muutumatu/muudetav	σταθερή/μεταβλητή
AN	For luft-vand-varmepumper: Nominel luftgennemstrømning, ude	Für Luft-Wasser-Wärmepumpen: Nenn-Luftdurchsatz, außen	Õhu-vee-soojuspump: õhu nimivooluhulk, väliskeskonnas	Για αντλίες θερμότητας αέρα-νερού: Ονομαστική παροχή αέρα, εξωτερικού χώρου
AO	m³/h	m³/h	m³/h	m³/h
AP	Lydeffektniveau, inde/ude	Schalleistungspegel, innen/außen	Müravõimsustase, siseruumis/väliskeskonnas	Στάθμη ηχητικής ισχύος, εσωτερικού/ εξωτερικού χώρου
AQ	Emissioner af kvælstofilter	Stickoxidaustritt	Lämmastikoksiidide heide	Εκπομπές οξειδίου του αζώτου
AR	For vand/brine-vand-varmepumper: nominal brine- eller vandgennemstrømning, varmeveksler, ude	Für Wasser/Sole-Wasser-Wärmepumpen: Wasser- oder Sole-Nenndurchsatz	Vee-soojuskandja vee-vee-soojuspump: soojuskandja või vee nimivooluhulk, soojusvaheti väljas	Για αντλίες θερμότητας νερού-άλης-νερού: Ονομαστική παροχή άλης ή νερού, εναλλάκτη θερμότητας εξωτερικού χώρου
AS	For varmepumpeanlæg til kombineret rum- og brugsvarmingsopvarmning:	Kombiheizgerät mit Wärmepumpe	Soojuspumbaga vee-soojendi-küttesead:	Για θερμαντήρα συνδυασμένης λειτουργίας με αντλία θερμότητας
AT	Angivet forbrugsprofil	Angegebenes Lastprofil	Esitatud koormusprofiil	Δηλωμένο προφίλ φορτίου
AU	Energieeffektivitet ved vandopvarmning	Warmwasserbereitungs-Energieeffizienz	Vee soojendamise kasutegur	Ενεργειακή απόδοση θέρμανσης νερού
AV	Dagligt elforbrug	Täglicher Stromverbrauch	Päevane elektrienergiaarve	Ημερήσια κατανάλωση ηλεκτρικής ενέργειας
AW	Dagligt brændselsforbrug	Täglicher Brennstoffverbrauch	Päevane kütteenegiatarve	Ημερήσια κατανάλωση καυσίμου
AX	Kontaktplysninger	Kontakt	Kontaktandmed	Στοιχεία επικοινωνίας
AY	(*) For varmepumpeanlæg til rumopvarmning og varmepumpeanlæg til kombineret rum- og brugsvarmingsopvarmning er den nominelle nytteeffekt Prated lig med den dimensionerede last for opvarmning Pdesignh, og den nominelle nytteeffekt for et supplerende forsyningsanlæg Psup er lig med den supplerende varmeydelse sup(TJ).	(*) Für Heizgeräte und Kombiheizgeräte mit Wärmepumpe ist die Wärmenennleistung Prated gleich der Auslegungslast im Heizbetrieb Pdesignh und die Wärmenennleistung eines Zusatzheizgerätes Psup gleich der zusätzlichen Heizleistung sup(TJ).	(*) Soojuspumbaga kütteseadmet ja soojuspumbaga vee-soojendite-kütteseadmete nimisoojusvõimsus Prated on võrdne arutuslik soojusvõimsusega Pdesignh, lisakütteseadme Psup nimisoojusvõimsus on võrdne lisakütteseadme soojusvõimsusega sup(TJ).	(*) Για θερμαντήρες χώρου με αντλία θερμότητας και θερμαντήρες συνδυασμένης λειτουργίας με αντλία θερμότητας, η ονομαστική θερμική ισχύς Prated ισούται με το θερμαντικό φορτίο σχεδιασμού Pdesignh, και η ονομαστική θερμική ισχύς του συμπληρωματικού θερμαντήρα Psup ισούται με τη συμπληρωματική θερμαντική ισχύ sup(TJ).
AZ	(**) Hvis Cdh ikke bestemmes ved måling, er koefficienten for effektivitetstab som standard Cdh = 0,9.	(**) Wird der Cdh-Wert nicht durch Messung bestimmt, gilt für den Minderungsfaktor der Vorgabewert Cdh = 0,9.	(**) Kui tegur Cdh on määramata, võetakse vaikimisi Cdh = 0,9.	(**) Εάν ο Cdh δεν προσδιορίζεται με μέτρηση, ο εφ'ορισμού συντελεστής υποβάθμισης είναι Cdh = 0,9.
BA	1) Du skal tage de forholdsregler, der er beskrevet i installations-/brugervejledningen, når du samler, installerer og vedligeholder dette produkt.	1) Beim Montieren, Installieren und Warten des Geräts müssen die im Installations-/ Benutzerhandbuch beschriebenen Vorsichtsmaßnahmen eingehalten werden.	1) Seadme kokkupanekul, paigaldamisel ja hooldusele tuleb rakendada paigaldus-/kasutusjuhendis kirjeldatud ettevaatusabinõusid	1) Όταν συναρμολογείτε, εγκαθιστάτε και συντηρείτε αυτό το προϊόν, πρέπει να λαμβάνετε τις προφυλάξεις που περιγράφονται στο εγχειρίδιο εγκατάστασης/χρήσης.
BB	2) Hvis du er en erhvervsdrivende, der søger information om, hvordan man monterer støvsugerens uden at adlægge nogle dele, bedes du sende en e-mail til: erims.sec@samsung.com	2) Wenn Sie als Fachkraft Informationen zu zerstörungsfreier Demontage und Zerlegung benötigen, schreiben Sie bitte eine E-Mail an: erims.sec@samsung.com.	2) Kui olete professionaal, kes otsib teavet mittekahjustava lahivõtmise ja demonteerimise kohta, saateki palun e-kiri aadressil: erims.sec@samsung.com.	2) Εάν είστε επαγγελματίας και αναζητάτε πληροφορίες σχετικά με την αποσυρμολόγηση χωρίς να προκληθούν καταστροφές, στείλετε μήνυμα ηλεκτρονικού ταχυδρομείου στη διεύθυνση: erims.sec@samsung.com

# COMMISSION REGULATION (EU) No 813/2013 <sup>1)</sup>

No	French(FR)	Croatian(HR)	Italian(IT)	Latvian(LV)
I	RÈGLEMENT (UE) No 813/2013 DE LA COMMISSION	UREDBA KOMISIJE (EU) br. 813/2013	REGOLAMENTO (UE) N. 813/2013 DELLA COMMISSIONE	KOMISIJAS REGULA (ES) Nr. 813/2013
II	Les exigences d'écoconception applicables aux dispositifs de chauffage des locaux	Zahtjevi za ekološki dizajn grijač prostora	Le spécifique per la progettazione ecocompatibile per apparecchio il riscaldamento d'ambiente	Ekodizaina prasības par telpu sildītājs
A	Modèle(s); [informations d'identification du ou des modèles concernés]	Modeli(j); [informacije za identifikaciju modela na koji(-e) se informacije odnose]	Modelli; [Informazioni per identificare i modelli cui sono riferibili le informazioni]	Modelis(-i); [Informācija, ar ko identificē modeli(-us), uz kuru(-iem) informācija attiecas]
B	Pompes à chaleur air-eau; [oui/non]	Toplinska crpka zrak-voda; [da/ne]	Pompa di calore aria/acqua; [si/no]	Gaiss-ūdens siltumsūknis; [jā/nē]
C	Pompes à chaleur eau-eau; [oui/non]	Toplinska crpka voda-voda; [da/ne]	Pompa di calore acqua/acqua; [si/no]	Ūdens-ūdens siltumsūknis; [jā/nē]
D	Pompe à chaleur eau glycolée-eau; [oui/non]	Toplinska crpka slana voda-voda; [da/ne]	Pompa di calore salamoia/acqua; [si/no]	Sālsūdens-ūdens siltumsūknis; [jā/nē]
E	Pompes à chaleur basse température; [oui/non]	Niskotemperatūra toplinska crpka; [da/ne]	Pompa di calore a bassa temperatura; [si/no]	Zemas temperatūras diapazona siltumsūknis; [jā/nē]
F	Équipée d'un dispositif de chauffage d'appoint; [oui/non]	Opremljena dodatnim grijačem; [da/ne]	Con riscaldatore supplementare; [si/no]	Aprīkots ar papildu sildītāju; [jā/nē]
G	Dispositif de chauffage mixte par pompe à chaleur; [oui/non]	Kombinirani grijači s toplinskom crpkom; [da/ne]	Apparecchio misto a pompa di calore; [si/no]	Siltumsūkņa kombinētais sildītājs; [jā/nē]
H	Les paramètres sont déclarés pour l'application à moyenne température, excepté pour les pompes à chaleur basse température. Pour les pompes à chaleur basse température, les paramètres sont déclarés pour l'application à basse température.	Parametri se navode za uporabu pri srednjoj temperaturi, osim za niskotemperaturne toplinske crpke. Za niskotemperaturne toplinske crpke parametri se navode za uporabu pri niskoj temperaturi.	I parametri sono dichiarati per l'applicazione a temperatura media, tranne per le pompe di calore a bassa temperatura. Per le pompe di calore a bassa temperatura, i parametri sono dichiarati per l'applicazione a bassa temperatura.	Parametrus deklarē izmantošanai vidējas temperatūras diapazonā, izņemot zemas temperatūras diapazona siltumsūknēm. Zemas temperatūras diapazona siltumsūknēm parametrus deklarē izmantošanai zemas temperatūras diapazonā.
I	Les paramètres sont déclarés pour les conditions climatiques moyennes.	Parametri se navode za prosječne klimatske uvjete.	I parametri sono dichiarati per condizioni climatiche medie.	Parametrus deklarē vidējiem klimatiskajiem apstākļiem.
J	Caractéristique	Stavka	Elemento	Pozīcija
K	Symbole	Oznaka	Simbolo	Apzīmējums
L	Valeur	Vrijednost	Valore	Vērtība
M	Unité	Jedinica	Unità	Vienība
N	Puissance thermique nominale (*)	Nazivna toplinska snaga (*)	Potenza termica nominale (*)	Nominālā siltuma jauda (*)
O	Prated	Prated	Phominale	Prated
P	Efficacité énergétique saisonnière pour le chauffage des locaux	Sezonska enerģētiska učinkovitost grijanja prostora	Efficienza energetica stagionale del riscaldamento d'ambiente	Telpu apsildes sezonas energoefektivitāte
Q	Puissance calorifique déclarée à charge partielle pour une température intérieure de 20 °C et une température extérieure Tj	Deklarirani ogrievni kapacitēt za djelomično opterećenje pri unutarnjoj temperaturi od 20 °C i vanjskoj temperaturi Tj	Capacità di riscaldamento dichiarata a carico parziale, con temperatura interna pari a 20 °C e temperatura esterna Tj	Deklarētā jauda sildīšanai pie daļējas slodzes, ja temperatūra telpā ir 20 °C un ārējais temperatūra ir Tj
R	Coefficient de performance déclaré ou coefficient sur énergie primaire déclaré à charge partielle pour une température intérieure de 20 °C et une température extérieure Tj	Deklarirani koeficient učinkovitosti ili omjer primarne energije za djelomično opterećenje pri unutarnjoj temperaturi od 20 °C i vanjskoj temperaturi Tj	Coefficiente di prestazione dichiarato o indice di energia primaria per carico parziale, con temperatura interna pari a 20 °C e temperatura esterna Tj	Deklarētais lietderības koeficients vai primārās enerģijas patēriņa rādītājs pie daļējas slodzes, ja temperatūra telpā ir 20 °C un ārējais temperatūra ir Tj
S	COPd ou PERd	COPd ili PERd	COPd oppure PERd	COPd vai PERd
T	Tj = température bivalente	Tj = bivalentna temperatura	Tj = temperatura bivalente	Tj = bivalentā temperatūra
U	Tj = température limite de fonctionnement	Tj = grāniņa radna temperatura	Tj = temperatura limite di esercizio	Tj = darba režīma robežtemperatūra
V	Pour les pompes à chaleur air-eau: Tj = -15 °C (si TOL < -20 °C)	Za toplinske crpke zrak-voda: Tj = -15 °C (ako je TOL < -20 °C)	Per le pompe di calore aria/acqua: Tj = -15 °C (se TOL < -20 °C)	Gaiss-ūdens siltumsūknēm: Tj = -15 °C (ja TOL < -20 °C)
W	Température bivalente	Bivalentna temperatura	Temperatura bivalente	Bivalentā temperatūra
X	Pour les pompes à chaleur air-eau: température limite de fonctionnement	Za toplinske crpke zrak-voda: Grāniņa radna temperatura	Per le pompe di calore aria/acqua: temperatura limite di esercizio	Gaiss-ūdens siltumsūknēm: darba režīma robežtemperatūra
Y	Puissance calorifique sur un intervalle cyclique	Ogrievni kapacitēt intervāla ciklusa	Ciclicità degli intervalli di capacità per il riscaldamento	Cikliskā intervāla jauda sildīšanai
Z	Efficacité sur un intervalle cyclique	Učinkovitost intervāla ciklusa	Efficienza della ciclicità degli intervalli	Cikliskā intervāla efektivitāte
AA	COPcyc ou PERcyc	COPcyc ili PERcyc	COPcyc oppure PERcyc	COPcyc vai PERcyc
AB	Coefficient de dégradation (**)	Koeficient degradacije (**)	Coefficiente di degradazione (**)	Pazeminājuma koeficients (**)
AC	Température maximale de service de l'eau de chauffage	Grāniņa radna temperatura za grijanje vode	Temperatura limite di esercizio di riscaldamento dell'acqua	Ūdens uzsildīšanas darba režīma robežtemperatūra

No	French(FR)	Croatian(HR)	Italian(IT)	Latvian(LV)
AD	Consommation d'électricité dans les modes autres que le mode actif	Potrošnja energije u načinima koji ne uključuju aktivni način rada	Consumo energetico in modi diversi dal modo attivo	Jauda režims, kas nav darba režims
AE	Dispositif de chauffage d'appoint	Dodatni grijač	Riscaldatore supplementare	Papildu sildītājs
AF	Mode arrêt	Stanje isključenosti	Modo spento	Izslēgts režims
AG	Mode arrêt par thermostat	Stanje isključenosti termostata	Modo termostato spento	Izslēgta termostata režims
AH	Mode veille	Stanje mirovanja	Modo stand-by	Gaidstāves režims
AI	Mode résistance de carter active	Način rada grijača kućišta	Modo riscaldamento del carter	Kartera sildītāja režims
AJ	Type d'énergie utilisée	Vrsta utrošene energije	Tipo di alimentazione energetica	Pievadītās enerģijas veids
AK	Autres caractéristiques	Druge stavke	Altri elementi	Citas pozīcijas
AL	Régulation de la puissance	Upravljanje kapacitetom	Controllo della capacità	Jaudas regulēšana
AM	fixe/variable	fiksno/promjenljivo	fisso/variabile	fiksēta/maināma jauda
AN	Pour les pompes à chaleur air-eau: débit d'air nominal, à l'extérieur	Za toplinsku crpku zrak-voda: Nazivna stopa protoka zraka, na otvorenom	Per le pompe di calore aria/acqua: portata d'aria, all'esterno	Gaiss-ūdens siltumsūkņiem: nominālā gaisa caurplūde, ārpus telpām
AO	m <sup>3</sup> /h	m <sup>3</sup> /h	m <sup>3</sup> /h	m <sup>3</sup> /h
AP	Niveau de puissance acoustique, à l'intérieur/à l'extérieur	Razina zvucne snage, unutra/vani	Livello della potenza sonora, all'interno/all'esterno	Akustiskās jaudas līmenis telpās/ārpus telpām
AQ	Émissions d'oxydes d'azote	Emisija dūšokvog oksīda	Emissioni di ossidi di azoto	Slāpekļa oksīdu emisijas
AR	Pour les pompes à chaleur eau-eau ou eau glycolée-eau: débit nominal d'eau glycolée ou d'eau, échangeur thermique extérieur	Za toplinske crpke voda/slana voda-voda: Nazivna stopa protoka slane vode ili vode, na vanjskom izmjenjivaču topline	Per le pompe di calore acqua/acqua e salamoia/acqua: flusso di salamoia o acqua nominale, scambiatore di calore all'esterno	Ūdens vai sālsūdens-ūdens siltumsūkņiem: nominālā sālsūdens vai ūdens caurplūde, ārpus siltummaiņiem
AS	Pour les dispositifs de chauffage mixtes par pompe à chaleur:	Za kombinirane grijače s toplinskom crpkom:	Per gli apparecchi di riscaldamento misti a pompa di calore:	Siltumsūkņa kombinētajam sildītājam:
AT	Profil de soutirage déclaré	Deklarirani profil opterećenja	Profilo di carico dichiarato	Deklarētais slodzes profils
AU	Efficacité énergétique pour le chauffage de l'eau	Enerģetiska učinkovitost zagrijavanja vode	Efficienza energetica di riscaldamento dell'acqua	Ūdens uzsildīšanas energoefektivitāte
AV	Consommation journalière d'électricité	Dnevna potrošnja elektrīcne energije	Consumo quotidiano di energia elettrica	Dienas elektroenerģijas patēriņš
AW	Consommation journalière de combustible	Dnevna potrošnja goriva	Consumo quotidiano di combustibile	Dienas kurināmā patēriņš
AX	Coordonnées de contact	Podaci za kontakt	Recapiti	Kontakinformācija
AY	(*) Pour les dispositifs de chauffage des locaux par pompe à chaleur et les dispositifs de chauffage mixtes par pompe à chaleur, la puissance thermique nominale Prated est égale à la charge calorifique nominale Pdesignh et la puissance thermique nominale d'un dispositif de chauffage d'appoint Ppsup est égale à la puissance calorifique d'appoint sup(Tj).	(*) Za toplinske crpke za grijanje prostora i kombinirane grijače s toplinskom crpkom nazivna toplinska snaga Prated jednaka je projektnom ogrijevnom opterećenju Pdesignh, a nazivna toplinska snaga dodatnog grijača Ppsup jednaka je dodatnom ogrijevnom kapacitetu sup(Tj).	(*) Per gli apparecchi a pompa di calore per il riscaldamento d'ambiente e gli apparecchi di riscaldamento misti a pompa di calore, la potenza termica nominale Pnominale è pari al carico teorico per il riscaldamento Pdesignh e la potenza termica nominale di un riscaldatore supplementare Ppsup è pari alla capacità supplementare di riscaldamento sup(Tj).	(*) Siltumsūkņa telpu sildītājiem un siltumsūkņa kombinētajiem sildītājiem nominālā siltuma jauda Prated ir vienāda ar aprēķināto slodzi sildīšanai Pdesignh un papildu sildītāja nominālā siltuma jauda Ppsup ir vienāda ar sildīšanas papildu jaudu sup(Tj).
AZ	(**) Si le Cdh n'est pas déterminé par des mesures, le coefficient de dégradation par défaut est Cdh = 0,9.	(**) Ako Cdh nije određen mjerenjem, standardni koeficijent degradacije je Cdh = 0,9.	(**) Se Cdh non è determinato mediante misurazione, il coefficiente di degradazione è Cdh = 0,9.	(**) Ja Cdh nenosaka, izmantojot mērījumus, tad standarta pazeminājuma koeficients ir Cdh = 0,9.
BA	1) Des précautions, comme décrit dans le manuel d'installation/d'utilisation, doivent être prises lors du montage, de l'installation et de l'entretien de l'appareil.	1) Prilikom sastavljanja, instalacije i održavanja proizvoda potrebno je poduzeti mjere opreza navedene u priručniku za instalaciju / korisničkom priručniku.	1) Durante l'assemblaggio, l'installazione e la manutenzione di questo apparecchio vanno poste in atto tutte le avvertenze e le precauzioni che sono indicate nei manuali di installazione e per l'utente.	1) Montāža un produkta apkope jāveic saskaņā ar montāžas/lietošanas instrukciju.
BB	2) Si vous êtes un professionnel à la recherche des informations sur le démontage et le démantèlement, veuillez envoyer un e-mail à l'adresse: erims.sec@samsung.com	2) Ako ste stručnjak u potrazi za informacijama o nerazornom rastavljanju i rasklapanju, pošaljite elektroničku poruku na adresu: erims.sec@samsung.com	2) Se sei un tecnico e vuoi sapere come smontare in modo accurato e non distruttivo il prodotto, invia una email all'indirizzo: erims.sec@samsung.com	2) Ja esat meisters, kas meklē informāciju, kā demontēt un izjaukt ierīci, to nesabojājot, sūtiet e-pasta vēstuli uz adresi: erims.sec@samsung.com.

# COMMISSION REGULATION (EU) No 813/2013 <sup>1)</sup>

No	Lithuanian(LT)	Hungarian(HU)	Maltese(MT)	Dutch(NL)
I	KOMISIJS REGLAMENTAS (ES) Nr. 813/2013	A BIZOTTSÁG 813/2013/EU RENDELETE	REGOLAMENT TAL-KUMMISSJONI (UE) Nru 813/2013	VERORDENING (EU) Nr. 813/2013 VAN DE COMMISSIE
II	Ekologinio projektavimo reikalavimai už patalpų šildytuvus	A környezettudatos tervezésére vonatkozó követelményeket helyiségfűtő berendezés	Rekwiżiti tal-ekodisinn għall ħiter tal-post	De eisen inzake ecologisch ontwerp voor ruimteverwarmingstoestel
A	Modelis (-iai) (modelio (-ų), kuriam (-iems) taikoma informacija, identifikavimo duomenys)	Modell(ek); [az információk tárgyát képező modell(ek) megjelölése]	Mudell(i); [tagħrif li bih jiġi identifikat il-mudell/jiġu identifikati l-mudelli li magħhom huwa relatat dan it-tagħrif]	Modell(en); [informatie ter bepaling van het model waarop de informatie betrekking heeft]
B	Oro-vandens šilumos siurblys [taip / ne]	Levegő-víz típusú hőszivattyú; [igen/nem]	Pompa tas-šhana arja-ilma; [iva/le]	Lucht/water-warmtepomp; [ja/nee]
C	Vandens-vandens šilumos siurblys [taip / ne]	Víz-víz típusú hőszivattyú; [igen/nem]	Pompa tas-šhana ilma-ilma; [iva/le]	Water/water-warmtepomp; [ja/nee]
D	Tirpalo-vandens šilumos siurblys [taip / ne]	Sós víz-víz típusú hőszivattyú; [igen/nem]	Pompa tas-šhana salmura-ilma; [iva/le]	Pekel/water-warmtepomp; [ja/nee]
E	Žematemperatūris šilumos siurblys [taip / ne]	Alacsony hőmérsékletű hőszivattyú; [igen/nem]	Pompa tas-šhana b'temperatura baxxa; [iva/le]	Lagetemperatuurwarmtepomp; [ja/nee]
F	Ar yra papildomas šildytuvus [taip / ne]	Rendelkezik-e kiegészítő fűtőberendezés; [igen/nem]	Mgħhammar b'ħiter supplementari; [iva/le]	Uitgerust met aanvullend verwarmingstoestel; [ja/nee]
G	Kombinuotasis šildytuvus su šilumos siurbliu [taip / ne]	Hőszivattyús kombinált fűtőberendezés; [igen/nem]	Filter ikkombinat b'pompa tas-šhana; [iva/le]	Combinatieverwarmingstoestel met warmtepomp; [ja/nee]
H	Pateikiami naudojimo esant vidutinei temperatūrai parametrai, išskyrus atvejus, kai teikiama informacija apie žematemperatūris šilumos siurblius. Žematemperatūris šilumos siurblių atvejai pateikiami naudojimo esant žemai temperatūrai parametrai.	A paramétereket az alacsony hőmérsékletű hőszivattyúk kivételével a közepes hőmérsékletű használatra vonatkozóan kell megadni. Az alacsony hőmérsékletű hőszivattyúk esetében a paramétereket az alacsony hőmérsékletű használatra vonatkozóan kell megadni.	Il-parametri għandhom jinġataw għal applikazzjoni b'temperatura medja, blief għall-pompi tas-šhana b'temperatura baxxa. Għall-pompi tas-šhana b'temperatura baxxa, il-parametri għandhom jinġataw għal applikazzjoni b'temperatura baxxa.	Parameters moeten worden opgegeven voor toepassing op middelhoge temperatuur, uitgezonderd voor laagtemperatuurwarmtepompen. Voor laagtemperatuurwarmtepompen moeten parameters worden opgegeven bij toepassing op lage temperatuur.
I	Pateikiami naudojimo vidutinėmis klimato sąlygomis parametrai.	A paramétereket az átlagos éghajlati viszonyokra vonatkozóan kell megadni.	Il-parametri għandhom jinġataw għall-kundizzjonijiet klimatidi medji.	Parameters moeten worden opgegeven voor gemiddelde klimaatomstandigheden.
J	Parametras	Elem	Fattur	Kenmerk
K	Sutartinis ženklas	Jel	Simbolu	Symbol
L	Vertė	Érték	Valur	Waarde
M	Vienetai	Mértékegység	Unità	Eenheid
N	Vardinis šilumos atidavimas (*)	Mért hőteljesítmény (*)	Potenza termika nominali (*)	Nominale warmteafgifte (*)
O	Prated	Prated	Prated	Prated
P	Sezoninis energijos patalpoms šildyti vartojimo efektyvumas	Szezonális helyiségfűtési hatásfok	Effiġjenza enerġetika staġonali tat-tiŝhin tal-post	Seizoensgebonden energie-efficiëntie van ruimteverwarming
Q	Deklaruotasis šildymo pajėgumas su daline apkrova, esant 20 °C patalpų temperatūrai ir lauko temperatūrai Tj.	Névfleges fűtőteljesítmény részterhelés mellett, 20 °C beltéri és Tj kültéri hőmérsékleten:	Kapaċità tat-tiŝhin iddikjarata għal taġħbija parzjali b'temperatura ta'għewwa ta' 20 °C u temperatura ta'barra ta'Tj	Opgegeven verwarmingsvermogen voor deellast bij een binnentemperatuur van 20 °C en een buitentemperatuur Tj
R	Deklaruotasis veiksmingumo koeficientas arba pirminės energijos santykis su daline apkrova, esant 20 °C patalpų temperatūrai ir lauko temperatūrai Tj.	Névfleges fűtési jószágfok vagy primerenergia-hányados részterhelés mellett, 20 °C beltéri és Tj kültéri hőmérsékleten	Koeffiġjent iddikjarat tal-prestazzjoni jew proporzjon iddikjarat tal-enerġija primarja għal taġħbija parzjali b'temperatura ta'għewwa ta' 20 °C u temperatura ta'barra ta'Tj	Opgegeven prestatiecoëfficiënt of primaire-energie-verhouding voor deellast bij een binnentemperatuur van 20 °C en buitentemperatuur Tj
S	COPd arba PERd	COPd vagy PERd	COPd jew PERd	COPd or PERd
T	Tj = perėjimo į dvejojo šildymo režimą temperatūra	Tj = bivalens hőmérséklet	Tj = temperatūra bivalenti	Tj = bivalente temperatuur
U	Tj = ribinė veikimo temperatūra	Tj = megengedett üzemi hőmérséklet	Tj = temperatūra tal-limitu tat-ħaddim	Tj = uiterste bedrijfstemperatuur
V	Oro-vandens šilumos siurblių atveju – Tj = – 15 °C (jei TOL < – 20 °C)	Levegő-víz típusú hőszivattyúk esetében: Tj = – 15 °C (ha TOL < – 20 °C)	Għall-pompi tas-šhana arja-ilma: Tj = – 15 °C (jekk TOL < – 20 °C)	Voor lucht/water-warmtepompen: Tj = – 15 °C (als TOL < – 20 °C)
W	Perėjimo į dvejojo šildymo režimą temperatūra	Bivalens hőmérséklet	Temperatūra bivalenti	Bivalente temperatuur
X	Oro-vandens šilumos siurblių atveju – Ribinė veikimo temperatūra	Levegő-víz típusú hőszivattyúk esetében: Megengedett üzemi hőmérséklet	Għall-pompi tas-šhana arja-ilma: Temperatura tal-limitu tat-ħaddim	Voor lucht/water-warmtepompen: uiterste bedrijfstemperatuur
Y	Ciklinis pajėgumas šildymo režimu	Fűtési ciklusteljesítmény	Kapaċità tal-intervall oġġiku għat-tiŝhin	Cyclisch-intervalvermogen voor verwarming
Z	Ciklinis efektyvumas	Ciklikus jószágfok	Effiġjenza tal-intervall oġġiku	Cyclisch-intervallefficiëntie
AA	COPcyc arba PERcyc	COPcyc vagy PERcyc	COPcyc jew PERcyc	COPcyc or PERcyc
AB	Blogįjimo koeficientas (**)	Degradációs tényező (**)	Koeffiġjent ta' degradazzjoni (**)	Verliescoëfficiënt (**)
AC	Šildymo vandens ribinė veikimo temperatūra	Fűtővíz megengedett üzemi hőmérséklete	Temperatūra limitu tat-ħaddim għall-ilma tat-tiŝhin	Uiterste bedrijfstemperatuur van sanitair water

No	Lithuanian(LT)	Hungarian(HU)	Maltese(MT)	Dutch(NL)
AD	Vartojamoji galia ne aktyviąja veikseną	Energiąfogyasztás a főfunkción kívüli üzemmódban	Konsum tal-enerġija fil-modalitajiet minnbarra dik attiva	Elektriciteitsverbruik in andere standen dan de actieve modus
AE	Papildomas šildytuvas	Kiegészítő fűtőberendezés	Filter supplementari	Aanvullend verwarmingstoestel
AF	Išjungties veikseną	Kikapcsolt üzemmód	Modalità Mitfi	Uit-stand
AG	Termostato išjungties veikseną	Termostát által kikapcsolt üzemmód	Modalità bit-termostat mitfi	Thermostaat-uit-stand
AH	Budėjimo veikseną	Készenléti üzemmód	Modalità Stennja	Stand-by-stand
AI	Karterio šildymo veikseną	Forgattyúház-fűtési üzemmód	Modalità tal-Ħiter tal-kisi tal-krank	Carterverwarming-stand
AJ	Tiekiamos energijos rūšis	Energiabeveitel jellege	Tip ta' kontribut tal-enerġija	Soort energie-input
AK	Kiti parametrai	További elemek	oġġetti oħra	Andere kenmerken
AL	Pajėgumo valdymas	Teljesítményszabályozás	Kontroll tal-kapaċità	Vermogenscontrole
AM	pastovus/kintamas	rögzített/állítható	fiiss/varjabbli	vast/variabel
AN	Oro vandens šilumos siurbliju atveju – vardinis oro srautas (lauke)	Levegő-víz típusú hőszivattyúk esetében: Mért légtömögáram, kültéri	Għall-pompi tas-šhana arja-ilma: Rata nominali ta' fluss tal-arja fuq barra	Voor lucht/water-warmtepompen: nominaal luchtdebiet, buiten
AO	m³/h	m³/h	m³/h	m³/h
AP	Garso galios lygis (patalpoje/lauke)	Hangteljesítményszint, beltéri/kültéri	Livell ta' qawwa tal-ħoss, fuq barra/fuq ġewwa	Geluidsvermogensniveau, binnen/buiten
AQ	Išmetamų azoto oksidų kiekis	Nitrogén-oxid-kibocsátás	Emissjonijiet tal-ossidi tan-nitroġenu	Emissies van stikstofoxiden
AR	Vandens vandens ir tirpalo vandens šilumos siurbliju atveju – vardinis tirpalo arba vandens srautas (lauko šilumokaitėje)	Víz-/sós víz-víz típusú hőszivattyúk esetében: Mért sósvíz- vagy vizáramlási sebesség, kültéri hőcserélővel	Għall-pompi tas-šhana ilma-/salmura-ilma: Rata nominali ta' fluss tal-ilma jew tas-salmura, skambjatur tas-šhana li jkun jinsab fuq barra	Voor water/water- en pekel/water-warmtepompen: nominaal pekel-/waterdebiet, warmtewisselaar buiten
AS	Kombinuotojų šildytuvo su šilumos siurbliju atveju	Hőszivattyús kombinált fűtőberendezés esetében:	Għall-ħiters ikkombinati b'pompa tas-šhana:	Voor combinatieverwarmingstoestellen met warmtepomp:
AT	Deklaruotasis apkrovos profilis	Névleges terhelési profil	Profil tat-tagħbija ddiġjarat	Opgeven capaciteitsprofiel
AU	Enerģijos vandeniu šildyti vartojimo efektyvumas	Vizmeleģitėsi hatásfok	Effiċjenza enerġetika tat-tiħin tal-ilma	Energie-efficiëntie van waterverwarming
AV	Elektros energijos suvartojimas per parą	Napi villamosenergia-fogyasztás	Konsum ta' kuljum tal-elekttriku	Dagelijks elektriciteitsverbruik
AW	Kuro suvartojimas per parą	Napi tüzelőanyag-fogyasztás	Konsum ta' kuljum tal-ħwiel	Dagelijks brandstofverbruik
AX	Kontaktiniai duomenys	Elérhetőség	Dettalji ta' kuntatt	Contactgegevens
AY	(*) Patalpų šildytuvų su šilumos siurbliu ir kombinuotųjų šildytuvų su šilumos siurbliu atveju vardinis šilumos atidavimas Prated lygus projektinei apkrovai šildymo režimu Pdesignh, o papildomo šildytuvo vardinis šilumos atidavimas Psup lygus papildomam šildymo pajėgumui sup(Tj).	(*) Hőszivattyús helyiségfűtő berendezések és hőszivattyús kombinált fűtőberendezések esetében a Prated mért hőteljesítmény egyenlő a Pdesignh tervezési fűtési terheléssel, emellett a kiegészítő fűtőberendezés Psup mért hőteljesítménye megegyezik a sup(Tj) kiegészítő fűtőteljesítménnyel.	(*) Għall-ħiters tat-post b'pompa tas-šhana u għall-ħiters ikkombinati b'pompa tas-šhana, il-potenza termika nominali, Prated, hija daqs it-tagħbija tad-disinn għat-tiħin, Pdesignh, u l-potenza termika nominali ta' ħiter supplementari, Psup, hija daqs il-kapaċità supplementari tat-tiħin, sup(Tj).	(**) Voor ruimteverwarmingstoestellen met warmtepomp en combinatieverwarmingstoestellen met warmtepomp, is de nominale warmteafgifte Prated gelijk aan de ontwerpbelasting voor verwarming Pdesignh, en is de nominale warmteafgifte van een aanvullend verwarmingstoestel Psup gelijk aan het aanvullend vermogen voor verwarming sup(Tj).
AZ	(**) Jei Cdh nenustatomas matuojant, naudojama numatytoji blogėjimo koeficiento vertė Cdh = 0,9.	(**) Amennyiben a Cdh értéket nem mérésrel állapítják meg, akkor az alapértelmezett degradációs tényező: Cdh = 0,9.	(**) Jekk il-koeffiċjent ta' degradazzjoni, Cdh, ma jiġix stabilizzat bil-kejl, b'mod awtomatiku jitqies li huwa ta' Cdh = 0,9.	(**) Als Cdh niet door meting is bepaald, is de standaardwaarde van de verliescoëfficiënt Cdh = 0,9.
BA	1) Atliekant montavimo ir aptarmavimo darbus privaloma laikytis atsargumo priemonių, nurodytų diegimo/vartotojo vadove.	1) A termék összeszerelése, telepítése és a karbantartása során tartsa be a telepítési/használati útmutatóban leírt óvintézkedéseket.	1) Prewakzjonijiet kif deskritt fl-installazzjoni u l-utent manwali għandhom jittieħdu meta jlaqqa l'installazzjoni, u ž-zamma dan il-prodott	1) De voorzorgsmaatregelen die in de gebruikershandleiding worden beschreven, moeten in acht worden genomen bij montage, installatie en onderhoud van dit product.
BB	2) Jei esate specialistas ir ieškote informacijos kaip išardyti įrangą jos nepažeidžiant, parašykite el. laišką adresu: erims.sec@samsung.com	2) Ha Ön szakember, és információt keres az ártalmatlan szétszereléssel és bontással kapcsolatban, kérjük, küldjön egy e-mailt az: erims.sec@samsung.com címre.	2) Jekk inti persuna professjonali u qed tftitex informazzjoni fuq amara u zamar li ma jagħmilx dan, jekk jogħbok liagħat email fuq: erims.sec@samsung.com	2) Als u als professional op zoek bent naar informatie over de niet-destructieve demontage en ontmanteling, stuur dan een e-mail naar: erims.sec@samsung.com

# COMMISSION REGULATION (EU) No 813/2013<sup>1)</sup>

No	Polish(PL)	Portuguese(PT)	Romanian(RO)	Slovak(SK)
I	ROZPORZĄDZENIE KOMISJI (UE) NR 813/2013	REGULAMENTO (UE) No 813/2013 DA COMISSÃO	NARIADENIE KOMISIE (EÚ) č. 813/2013	NARIADENIE KOMISIE (EÚ) č. 813/2013
II	Wymogi dotyczące ekoprojektu dla ogrzewaczy pomieszczeń	Os requisitos de concepção ecológica para aquecedor de ambiente	Požiadavky na ekodizajn tepelný zdroj na vykurovanie priestoru	Požiadavky na ekodizajn tepelný zdroj na vykurovanie priestoru
A	Model(-e); [dane określające modele, do których odnoszą się informacje]	Modelo(s); [dados de identificação do(s) modelo(s) a que se refere a informação]	Model(-y); [informácie na určenie modelu(-ov), ktorého(-ých) sa informácie týkajú]	Model(-y); [informácie na určenie modelu(-ov), ktorého(-ých) sa informácie týkajú]
B	Pompa ciepła powietrze/woda: [tak/nie]	Bomba de calor ar-água: [sim/não]	Tepelné čerpadlo vzduch – voda: [áno/nie]	Tepelné čerpadlo vzduch – voda: [áno/nie]
C	Pompa ciepła woda/woda: [tak/nie]	Bomba de calor água-água: [sim/não]	Tepelné čerpadlo voda – voda: [áno/nie]	Tepelné čerpadlo voda – voda: [áno/nie]
D	Pompa ciepła solanka/woda: [tak/nie]	Bomba de calor salmoura-água: [sim/não]	Tepelné čerpadlo slaná voda – voda: [áno/nie]	Tepelné čerpadlo studničná voda – voda: [áno/nie]
E	Niskotemperaturowa pompa ciepła: [tak/nie]	Bomba de calor de baixa temperatura: [sim/não]	Nizkoteplotné tepelné čerpadlo: [áno/nie]	Nizkoteplotné tepelné čerpadlo: [áno/nie]
F	Wyposażona w dodatkowy ogrzewacz: [tak/nie]	Equipada com um aquecedor suplementar: [sim/não]	Vybavené dodatočným tepelným zdrojom: [áno/nie]	Vybavené dodatočným tepelným zdrojom: [áno/nie]
G	Wielofunkcyjny ogrzewacz z pompą ciepła: [tak/nie]	Aquecedor combinado com bomba de calor: [sim/não]	Kombinovaný tepelný zdroj – tepelné čerpadlo: [áno/nie]	Kombinovaný tepelný zdroj – tepelné čerpadlo: [áno/nie]
H	Parametry podaje się dla zastosowań w średnich temperaturach, z wyjątkiem niskotemperaturowych pomp ciepła. W przypadku niskotemperaturowych pomp ciepła parametry podaje się dla zastosowań w niskich temperaturach.	Devem ser indicados parâmetros para aplicação a média temperatura, exceto para as bombas de calor de baixa temperatura. Para as bombas de calor de baixa temperatura, devem ser indicados parâmetros para aplicação a baixa temperatura.	Parametre sa deklaruujú pre použitie pri stredných teplotách, okrem tepelných čerpadiel pre nízke teploty. V prípade tepelných čerpadiel pre nízke teploty sa parametre deklaruujú pre použitie pri nízkych teplotách.	Parametre majú byť deklarované pre použitie pri stredných teplotách, okrem tepelných čerpadiel pre nízke teploty. V prípade tepelných čerpadiel pre nízke teploty sa parametre majú byť deklarované pre použitie pri nízkych teplotách.
I	Parametry są deklarowane dla warunków klimatu umiarkowanego.	Os parâmetros declarados devem corresponder a condições climáticas médias.	Parametre sa deklaruujú pre priemerné klimatické podmienky.	Parametre majú byť deklarované pre priemerné klimatické podmienky.
J	Parametr	Elemento	Položka	Položka
K	Symbol	Símbolo	Symbol	Symbol
L	Wartość	Valor	Hodnota	Hodnota
M	Jednostka	Unidade	Jednotka	Jednotka
N	Znamionowa moc cieplna (*)	Potência calorífica nominal (*)	Menovitý tepelný výkon (*)	Menovitý tepelný výkon (*)
O	Prated	Prated	Prated	Prated
P	Sezonowa efektywność energetyczna ogrzewania pomieszczeń	Eficiência energética do aquecimento ambiente sazonal	Sezónna energetická účinnosť vykurovania	Sezónna energetická účinnosť vykurovania
Q	Deklarowana wydajność grzewcza przy częściowym obciążeniu w temperaturze pomieszczenia 20 °C i temperaturze zewnętrznej Tj	Capacidade declarada para aquecimento a carga parcial a uma temperatura interior de 20 °C e a uma temperatura exterior Tj	Deklarovaný tepelný výkon pre čiastočné zaťaženie pri vnútornej teplote 20 °C a vonkajšej teplote Tj	Deklarovaný tepelný výkon pre čiastočné zaťaženie pri vnútornej teplote 20 °C a vonkajšej teplote Tj
R	Deklarowany wskaźnik efektywności lub wskaźnik zużycia energii pierwotnej przy częściowym obciążeniu w temperaturze pomieszczenia 20 °C i temperaturze zewnętrznej Tj	Coefficiente de desempenho declarado ou rácio de energia primária a carga parcial a uma temperatura interior de 20 °C e a uma temperatura exterior Tj	Deklarovaný vykurovací súčiniteľ alebo súčiniteľ využitia primárnej energie pre čiastočné zaťaženie pri vnútornej teplote 20 °C a vonkajšej teplote Tj	Deklarovaný vykurovací súčiniteľ alebo súčiniteľ využitia primárnej energie pre čiastočné zaťaženie pri vnútornej teplote 20 °C a vonkajšej teplote Tj
S	COPd lub PERd	COPd ou PERd	COPd alebo PERd	COPd alebo PERd
T	Tj = temperatura dwuwartościowa	Tj = temperatura bivalente	Tj = bivalentná teplota	Tj = teplota bivalencie
U	Tj = graniczna temperatura robocza	Tj = temperatura-limite de funcionamento	Tj = prevádzková hraničná teplota	Tj = hraničná prevádzková teplota
V	Pompy ciepła powietrze/woda: Tj = - 15 °C (jeżeli TOL < - 20 °C)	Para bombas de calor ar-água: Tj = - 15 °C (se TOL < - 20 °C)	Pre tepelné čerpadlá vzduch – voda: Tj = - 15 °C (ak TOL < - 20 °C)	Pre tepelné čerpadlá vzduch – voda: Tj = - 15 °C (ak TOL < - 20 °C)
W	Temperatura dwuwartościowa	Temperatura bivalente	Bivalentná teplota	Teplota bivalencie
X	Pompy ciepła powietrze/woda: Graniczna temperatura robocza	Para bombas de calor ar-água: Temperatura-limite de funcionamento	Pre tepelné čerpadlá vzduch – voda: Hraničná prevádzková teplota	Pre tepelné čerpadlá vzduch – voda: Hraničná prevádzková teplota
Y	Wydajność w okresie cyklu w intervale dla ogrzewania	Capacidade de aquecimento em intervalo cíclico	Výkon v rámci cyklického intervalu pre vykurovanie	Výkon v rámci cyklického intervalu pre vykurovanie
Z	Wydajność w okresie cyklu w intervale	Eficiência em intervalo cíclico	Súčiniteľ v rámci cyklického intervalu	Súčiniteľ v rámci cyklického intervalu
AA	COPcyc lub PERcyc	COPcyc ou PERcyc	COPcyc alebo PERcyc	COPcyc alebo PERcyc
AB	Współczynnik strat (**)	Coefficiente de degradação (**)	Súčiniteľ straty účinnosti (**)	Súčiniteľ straty účinnosti (**)
AC	Graniczna temperatura robocza dla podgrzewania wody	Temperatura-limite de funcionamento para água de aquecimento	Hraničná prevádzková teplota pre ohrev úžitkovej vody	Hraničná prevádzková teplota pre ohrev vody

No	Polish(PL)	Portuguese(PT)	Romanian(RO)	Slovak(SK)
AD	Pobór mocy w trybach innych niż aktywny	Consumo energético em modos distintos do modo ativo	Elektrický príkon v iných režimoch ako aktívny režim	Spotreba el. energie v iných režimoch ako aktívnych
AE	Ogrzewacz dodatkowy	Aquecedor suplementar	Dodatočný tepelný zdroj	Dodatočný tepelný zdroj
AF	Tryb wyłączenia	Modo desligado	Režim vypnutia	Režim vypnutia
AG	Tryb wyłączzonego termostatu	Modo termostato desligado	Režim vypnutia termostatu	Režim vypnutia termostatu
AH	Tryb czuwania	Modo de vigília	Pohotovostný režim	Pohotovostný režim
AI	Tryb włącznej grzałki karteru	Modo de resistência do cárter	Režim ohrevu kľukovej skrine	Režim nahrievania oleja
AJ	Rodzaj pobieranej energii	Tipo de alimentação de energia	Typ elektrického príkonu	Typ elektrického príkonu
AK	Inne parametry	Outros elementos	Allj parametri	Iné položky
AL	Regulacja wydajności	Controlo de capacidade	Regulácia výkonu	Regulácia výkonu
AM	wydajność stała/zmienna	fixo/variável	Pevná/premenlivá	Pevná/premenlivá
AN	Pompy ciepła powietrze/woda: znamionowy przepływ powietrza na zewnątrz	Para bombas de calor ar-água: Caudal de ar nominal, exterior	Pre tepelné čerpadlá vzduch – voda: Menovitý prietok vzduchu, von	Pre tepelné čerpadlá vzduch – voda: Menovitý prietok vzduchu, exteriér
AO	m <sup>3</sup> /h	m <sup>3</sup> /h	m <sup>3</sup> /h	m <sup>3</sup> /h
AP	Poziom mocy akustycznej w pomieszczeniu/ na zewnątrz	Nível de potência sonora interior/exterior	Vnútnorná/vonkajšia hladina akustického výkonu	Vnútnorná/vonkajšia hladina akustického výkonu
AQ	Emisje tlenków azotu	Emissões de óxidos de azoto	Emisie oxidov dusíka	Emisie oxidov dusíka
AR	Pompy ciepła woda/solanka-woda: znamionowe natężenie przepływu solanki lub wody, zewnętrzny wymiennik ciepła	Para bombas de calor água/salmoura-água: Caudal nominal de salmoura ou água, permutador térmico exterior	Pre tepelné čerpadlá voda/slaná voda – voda: Menovitý prietok slanej vody alebo vody, vonkajší výmenník tepla	Pre tepelné čerpadlá voda/studničná voda – voda: Menovitý prietok studničnej vody alebo vody, vonkajší výmenník tepla
AS	Wielofunkcyjne ogrzewacze z pompą ciepła:	Para aquecedores combinados com bomba de calor.	Pre kombinovaný tepelný zdroj – tepelné čerpadlo:	Pre kombinovaný tepelný zdroj tepelného čerpadla:
AT	Deklarowany profil obciążeń	Perfil de carga declarado	Deklarowany profil zaťaženia	Deklarovaný profil zaťaženia
AU	Efektywność energetyczna podgrzewania wody	Eficiência energética do aquecimento de água	Energetická účinnosť prípravy teplej vody	Energetická účinnosť prípravy teplej vody
AV	Dzienne zużycie energii elektrycznej	Consumo diário de eletricidade	Denná spotreba elektrickej energie	Denná spotreba elektrickej energie
AW	Dzienne zużycie paliwa	Consumo diário de combustível	Denná spotreba paliwa	Denná spotreba paliwa
AX	Dane kontaktowe	Elementos de contacto	Kontaktne údaje	Kontaktne údaje
AY	(*) W przypadku ogrzewaczy pomieszczeń z pompą ciepła i wielofunkcyjnych ogrzewaczy z pompą ciepła znamionowa moc cieplna Prated jest równa obciążeniu obliczeniowemu dla trybu ogrzewania Pdesignh, a znamionowa moc cieplna ogrzewacza dodatkowego Psup jest równa dodatkowej wydajności grzewczej dla trybu ogrzewania sup(Tj).	(*) Para aquecedores de ambiente com bomba de calor e aquecedores combinados com bomba de calor, a potência calorífica nominal Prated é igual à carga de projeto para aquecimento Pdesignh e a potência calorífica nominal de um aquecedor suplementar Psup é igual à capacidade de aquecimento suplementar sup(Tj).	(*) Pre tepelné zdroje na vykurovanie priestoru – tepelné čerpadlá a kombinované tepelné zdroje – tepelné čerpadlá sa menovitý tepelný výkon Prated rovná projektovanému vykurovaciemu zaťaženiu Pdesignh, a menovitý tepelný výkon dodatčného tepelného zdroja Psup sa rovná dodatocnému tepelnému výkonu sup(Tj).	(*) Pre tepelné zdroje na vykurovanie priestoru – tepelné čerpadlá a kombinované tepelné zdroje sa menovitý tepelný výkon Prated rovná projektovanému vykurovaciemu zaťaženiu Pdesignh a menovitý tepelný výkon dodatčného tepelného zdroja Psup sa rovná dodatocnému tepelnému výkonu sup(Tj).
AZ	(**) Jeżeli współczynnik Cdh nie został wyznaczony przez pomiar, współczynnik strat przyjmuje wartość domyślną Cdh = 0,9.	(**) Se não se determinar Cdh por medição, o coeficiente de degradação predefinido é Cdh = 0,9.	(**) Ak Cdh nie je určené meraním, implicitný súčiniteľ straty účinnosti je Cdh = 0,9.	(**) Ak Cdh nie je určené meraním, potom predvolený súčiniteľ straty účinnosti je Cdh = 0,9.
BA	1) W trakcie montażu, instalacji i obsługi tego produktu należy zachować zasady bezpieczeństwa opisane w instrukcji instalacji/obsługi.	1) As precauções descritas no manual de instalação/instruções dever ser adotadas durante a montagem, instalação ou manutenção do produto.	1) Trebuie să fiți precauți conform manualului de utilizare/instalare în timpul asamblării, instalării și întreinerii acestui produs.	1) Vystrahy ako sú popísané v inštaláčnom/ užívateľskom manuáli musia byť uvažované pri montáži, inštalácii a starostlivosti o produkt.
BB	2) Jeśli jesteś profesjonalistą szukającym informacji dotyczących nieniszczących metod demontażu i rozbiórki, uprzejmie prosimy o wysłanie wiadomości email na adres: erims.sec@samsung.com	2) Se é um profissional e pretende obter informações sobre desmontagem e desmantelamento não destrutivos, envie um e-mail para: erims.sec@samsung.com	2) Odborní pracovníci môžu získať informácie týkajúce sa nedestruktívnej demontáže na nasledujúcej e-mailovej adrese: erims.sec@samsung.com.	2) Odborní pracovníci môžu získať informácie týkajúce sa správnej demontáže na nasledujúcej e-mailovej adrese: erims.sec@samsung.com.

# COMMISSION REGULATION (EU) No 813/2013 <sup>1)</sup>

No	Slovenian(SL)	Finnish(FI)	Swedish(SV)
I	UREDBA KOMISIJE (EU) št. 813/2013	KOMISSION ASETUS (EU) No 813/2013,	KOMMISSIONENS FÖRORDNING (EU) nr 813/2013
II	Okoljsko primerno zasnovane zahteve za grelnik prostorov	Ekosuunnitteluvaatimukset varten tilälämmittimellä	Ekodesignkraven för rumsuppvärmning
A	Model(-i); [informacije za identifikacijo modela(-lov), na katere se informacije nanašajo]	Malli(t); [tiedot sen mallin (niden mallien) yksilöllisiksi, joita tiedot koskevat]	Modell(er); [Information som identifierar den modell (de modeller) som informationen gäller]
B	Toplotna črpalka zrak-voda: [da/ne]	Ilma-vesi-lämpöpumppu: [kyllä/ei]	Luft-till-vatten-värmepump: [ja/nej]
C	Toplotna črpalka voda-voda: [da/ne]	Vesi-vesi-lämpöpumppu: [kyllä/ei]	Vatten-till-vatten-värmepump: [ja/nej]
D	Toplotna črpalka slanica-voda: [da/ne]	Suolavesi-vesi-lämpöpumppu: [kyllä/ei]	Saltlösning-till-vatten-värmepump: [ja/nej]
E	Nizkoteperaturna toplotna črpalka: [da/ne]	Matalan lämpötilan lämpöpumppu: [kyllä/ei]	Lågtemperaturvärmepump: [ja/nej]
F	Opremljena z dodatnim grelnikom: [da/ne]	Varustettu lisälämmittimellä: [kyllä/ei]	Urustad med extra värmegenerator: [ja/nej]
G	Kombinirani grelnik s toplotno črpalko: [da/ne]	Lämpöpumppuyhdistelmälämmitin: [kyllä/ei]	Pannor med inbyggd tappvarmvattenberedning och med värmepump: [ja/nej]
H	Parametri se navedejo za uporabo pri srednji temperaturi, razen za nizkoteperaturne toplotne črpalke. Parametri za nizkoteperaturne toplotne črpalke se navedejo za uporabo pri nizki temperaturi.	Parametrit ilmoitetaan keskilämpötilan sovelluksesta, lukuun ottamatta matalan lämpötilan lämpöpumppuja. Matalan lämpötilan lämpöpumppuista parametrit ilmoitetaan matalan lämpötilan sovelluksesta.	Parametrar ska anges för mediumtemperaturlämplning, utom för lågtemperaturvärmepumpar. För lågtemperaturvärmepumpar ska parametrarna anges för lågtemperaturapplikationer.
I	Parametri se navedejo za povprečne podnebne razmere.	Parametrit ilmoitetaan keskimääräisissä ilmasto-olosuhteissa.	Parametrarna ska anges för genomsnittliga klimatförhållanden.
J	Postavka	Kohta	Post
K	Oznaka	Symboli	Beteckning
L	Vrednost	Arvo	Värde
M	Enota	Yksikkö	Enhet
N	Nazivna izhodna toplota (*)	Nimellislämpöteho (*)	Nominell avgiven värmeeffekt (*)
O	Prated	Prated	Pmärk
p	Sezonska energijska učinkovitost ogrevanja prostorov	Tilälämmityksen kausittainen energiatehokkuus	Säsongsmedelverkningsgrad för rumsuppvärmning
Q	Prijavljena zmogljivost ogrevanja za delno obremenitev pri temperaturi v notranjih prostorih 20 °C in temperaturi na prostem Tj	Ilmoitettu lämmitysteho osakuormalla sisälämpötilassa 20 °C ja ulkolämpötilassa Tj	Deklarerad kapacitet för uppvärmning för delbelastning vid innetemperatur 20 °C och utetemperatur Tj
R	Prijavljen koeficient učinkovitosti ali razmerje primarne energije za delno obremenitev pri temperaturi v notranjih prostorih 20 °C in temperaturi na prostem Tj	Ilmoitettu lämpökerroin tai primäärienergiakerroin osakuormalla sisälämpötilassa 20 °C ja ulkolämpötilassa Tj	Deklarerad värmefaktor eller primärenergifaktor för delbelastning vid en inomhustemperatur på 20 °C och en utomhustemperatur Tj
S	COPd ali PERd	COPd tai PERd	COPd eller PERd
T	Tj = bivalentna temperatura	Tj = kaksiarvoinen lämpötila	Tj = bivalenttemperatur
U	Tj = mejna delovna temperatura	Tj = toimintarajalämpötila	Tj = gränstemperatur för drift
V	Za toplotne črpalke zrak-voda: Tj = - 15 °C (če je TOL < - 20 °C)	Ilma-vesi-lämpöpumput: Tj = - 15 °C (jos TOL < - 20 °C)	För luft-till-vatten-värmepumpar: Tj = - 15 °C (om TOL < - 20 °C)
W	Bivalentna temperatura	Kaksiarvoinen lämpötila	Bivalenttemperatur
X	Za toplotne črpalke zrak-voda: mejna delovna temperatura	Ilma-vesi-lämpöpumput: Toimintarajalämpötila	För luft-till-vatten-värmepumpar: Gränstemperatur för drift
Y	Zmogljivost intervala cikla za ogrevanje	Lämmityksen vuorottelujaksoteho	Cykelintervallets uppvärmningskapacitet
Z	Učinkovitost intervala cikla	Vuorottelujakson energiatehokkuus	Cykelintervallets verkningsgrad
AA	COPcyc ali PERcyc	COPcyc tai PERcyc	COPcyc eller PERcyc
AB	Koeficient degradacije (**)	Alenemiskerroin (**)	Degraderingskoefficient (**)
AC	Mejna delovna temperatura za ogrevanje vode	Lämmitysveden toimintarajalämpötila	Uppvärmningsvattnets gränstemperatur för drift
AD	Poraba energije v načinih, ki ne vključujejo načina aktivnega delovanja	Tehtonkulutus muissa tiloissa kuin aktiivisessa toimintatilassa	Effektförbrukning i andra lägen än aktivt läge
AE	Dodatni grelnik	Lisälämmitin	Extra värmegenerator
AF	Stanje izključenosti	Pois päältä -tila	Frånläge



No	Slovenian(SL)	Finnish(FI)	Swedish(SV)
AG	Stanje izključnosti termostata	Termostaatti pois päältä -tila	Termostatfrånläge
AH	Stanje pripravljenosti	Valmiustila	Standbyläge
AI	Način grelnika ohisja	Kampikammion lämmitys -tila	Vevhusvärmärläge
AJ	Vrsta dovedene energije	Ottoenergian tyyppi	Typ av tillförd energi
AK	Druge postavke	Muut kohdat	Andra poster
AL	Upravljanje zmožljivosti	Tehonsäätö	Kapacitetsreglering
AM	stalna/spremenljiva	kiinteä/muuttuva	fast/variabel
AN	Za toplotne črpalke zrak-voda: nazivna stopnja pretoka zraka, zunanja	Ilma-vesi-lämpöpumpput: nimellisilmavirta, ulkona	För luft-till-vatten-värmepumpar: Nominellt luftflöde (ute)
AO	m <sup>3</sup> /h	m <sup>3</sup> /h	m <sup>3</sup> /h
AP	Nivo zvokovne moči, v notranjih prostorih/na prostem	Äänitehotaso, sisällä/ulkona	Ljudeffektiv, inomhus/utomhus
AQ	Emisije dušikovih oksidov	Tyypen oksidien päästöt	Utsläpp av kväveoxider
AR	Za toplotne črpalke voda/slaniica-voda: nazivna stopnja pretoka slaniice ali vode, zunanji izmenjevalnik toplote	Vesi-/suolavesi-vesi-lämpöpumpput: suolaveden tai veden nimellisvirtaus, ulkolämmönsiirrin	För vatten-/saltlösning-till-vatten-värmepumpar: Nominellt saltlösning- eller vattenflöde, värmväxlare utomhus
AS	Za kombinirani grelnik s toplotno črpalke:	Lämpöpumpppyhdistelmälämmitin:	För pannor med inbyggd tappvarmvattenberedning och med värmepump:
AT	Določeni profil rabe	Ilmoitettu kuormitusprofiili	Deklarerad belastningsprofil
AU	Energijska učinkovitost ogrevanja vode	Vedenlämmityksen energiatehokkuus	Energieffektivitet vid uppvärmning av vatten
AV	Dnevna poraba električne energije	Vuorokautinen sähkönkulutus	Daglig elförbrukning
AW	Dnevna poraba goriva	Vuorokautinen polttoainekulutus	Daglig bränsleförbrukning
AX	Kontaktni podatki	Yhteydet	Kontakt
AY	(*) Za toplotne črpalke za ogrevanje prostorov in kombinirane grelnike s toplotno črpalke je nazivna izhodna toplota Prated enaka nazivni obremenitvi za ogrevanje Pdesignh, nazivna izhodna toplota dodatnega grelnika Pspup pa je enaka dodatni zmožljivosti ogrevanja sup(Tj).	(*) Lämpöpumpputilälämmittimillä ja lämpöpumpppyhdistelmälämmittimillä nimellislämpöteho Prated on yhtä suuri kuin lämmityksen mitoituskuorma Pdesignh ja lisälämmittimen nimellislämpöteho Pspup on yhtä suuri kuin lisälämmitysteho sup(Tj).	(*) För värmare med värmepump för rumsuppvärmning och pannor med inbyggd tappvarmvattenberedning och med värmepump är den nominella avgivna värmeeffekten Prated lika med den dimensionerade värmekapaciteten Pdesignh, och den nominella avgivna värmeeffekten hos en extra värmegenerator Pspup är lika med den kompletterande uppvärmningskapaciteten sup(Tj).
AZ	(**) Če Cdh ni določen z meritvami, privzeti koeficient degradacije znaša Cdh = 0,9.	(**) Jos Cdh:n arvoa ei määritetä mittaamalla, alenemiskertoimen oletusarvo on Cdh = 0,9.	(**) Om Cdh inte bestäms genom mätningar ska degraderingskoefficienten vara Cdh = 0,9.
BA	1) Pri sestavljanju, nameščanju ter vzdrževanju izdelka upoštevajte previdnostne ukrepe, ki so navedeni v priložnici za uporabo in namestitve.	1) Asennus- tai käyttöoppaassa kuvattuja turvaohjeita on noudatettava laitteen kokoamisen, asentamisen ja huollon aikana.	1) Försiktighetsåtgärderna som beskrivs i installationsmanualen/bruksanvisningen måste följas vid montering, installation och underhåll av denna produkt.
BB	2) Če ste strokovnjak in iščete informacije o neporušitem razstavljanju in demontaži, pošljite e-pošto sporočilo na: erims.sec@samsung.com	2) Jos olet ammattiasentaja ja haluat lisätietoja asennuksen turvallisuudesta purkamisesta, lähettäkää sähköpostia osoitteeseen erims.sec@samsung.com	2) Om du är en professionell användare som letar efter information om icke-destruktiv demontering och isärtagande av dammsugaren, kan du skicka ett e-postmeddelande till: erims.sec@samsung.com

# COMMISSION DELEGATED REGULATION (EU) No 811/2013 <sup>i)</sup>

## PRODUCT FICHE (ENERGY LABELLING OF SPACE HEATERS) <sup>ii)</sup>

a	Supplier's name or trademark		Samsung Electronics Co., Ltd.	Samsung Electronics Co., Ltd.	Samsung Electronics Co., Ltd.	Samsung Electronics Co., Ltd.	
b	Supplier's model identifier		AE090JXEDEH/ AE090JNYDEH	AE090JXEDGH/ AE090JNYDGH	AE120JXEDEH/ AE160JNYDEH	AE120JXEDGH/ AE160JNYDGH	
c	Seasonal space heating energy efficiency class	Medium-temperature <sup>6)</sup>	-	A++	A++	A+	A+
		Low-temperature <sup>6)</sup>	-	A++	A++	A++	A++
d	Rated heat output (Average)	Medium-temperature <sup>6)</sup>	kW	6	6	8	8
		Low-temperature <sup>6)</sup>	kW	7	7	11	11
e	Seasonal space heating energy efficiency (Average)	Medium-temperature <sup>6)</sup>	%	128	131	112	112
		Low-temperature <sup>6)</sup>	%	178	180	180	180
f	Annual energy consumption (Average)	Medium-temperature <sup>6)</sup>	kWh	2704	2732	4000	4000
		Low-temperature <sup>6)</sup>	kWh	2139	2178	3298	3298
g	L <sub>WA</sub> (sound power level, indoor)		dB	40	40	47	47
h	Specific precautions <sup>1)</sup>		-	-	-	-	-
i	Rated heat output (Colder)	Medium-temperature <sup>6)</sup>	kW	5	5	8	8
		Low-temperature <sup>6)</sup>	kW	6	6	11	11
j	Rated heat output (Warmer)	Medium-temperature <sup>6)</sup>	kW	6	6	8	8
		Low-temperature <sup>6)</sup>	kW	7	7	11	11
k	Seasonal space heating energy efficiency (Colder)	Medium-temperature <sup>6)</sup>	%	108	112	107	107
		Low-temperature <sup>6)</sup>	%	154	162	169	169
l	Seasonal space heating energy efficiency (Warmer)	Medium-temperature <sup>6)</sup>	%	154	132	157	157
		Low-temperature <sup>6)</sup>	%	238	252	232	232
m	Annual energy consumption (Colder)	Medium-temperature <sup>6)</sup>	kWh	3875	3900	6292	6292
		Low-temperature <sup>6)</sup>	kWh	3164	3103	5275	5275
n	Annual energy consumption (Warmer)	Medium-temperature <sup>6)</sup>	kWh	2255	2715	2992	2992
		Low-temperature <sup>6)</sup>	kWh	1694	1644	2752	2752
o	L <sub>WA</sub> (sound power level, outdoor)		dB	64	64	64	64

a	Supplier's name or trademark		Samsung Electronics Co., Ltd.	Samsung Electronics Co., Ltd.	Samsung Electronics Co., Ltd.	Samsung Electronics Co., Ltd.	
b	Supplier's model identifier		AE140JXEDEH/ AE160JNYDEH	AE140JXEDGH/ AE160JNYDGH	AE160JXEDEH/ AE160JNYDEH	AE160JXEDGH/ AE160JNYDGH	
c	Seasonal space heating energy efficiency class	Medium-temperature <sup>6)</sup>	-	A+	A+	A+	A+
		Low-temperature <sup>6)</sup>	-	A++	A++	A++	A++
d	Rated heat output (Average)	Medium-temperature <sup>6)</sup>	kW	9	9	10	10
		Low-temperature <sup>6)</sup>	kW	12	12	13	13
e	Seasonal space heating energy efficiency (Average)	Medium-temperature <sup>6)</sup>	%	110	110	108	108
		Low-temperature <sup>6)</sup>	%	179	179	178	178
f	Annual energy consumption (Average)	Medium-temperature <sup>6)</sup>	kWh	4327	4327	4926	4926
		Low-temperature <sup>6)</sup>	kWh	3594	3594	3933	3933
g	L <sub>WA</sub> (sound power level, indoor)		dB	47	47	47	47
h	Specific precautions <sup>1)</sup>		-	-	-	-	-
i	Rated heat output (Colder)	Medium-temperature <sup>6)</sup>	kW	9	9	10	10
		Low-temperature <sup>6)</sup>	kW	12	12	13	13
j	Rated heat output (Warmer)	Medium-temperature <sup>6)</sup>	kW	9	9	10	10
		Low-temperature <sup>6)</sup>	kW	12	12	13	13
k	Seasonal space heating energy efficiency (Colder)	Medium-temperature <sup>6)</sup>	%	109	109	113	113
		Low-temperature <sup>6)</sup>	%	170	170	173	173
l	Seasonal space heating energy efficiency (Warmer)	Medium-temperature <sup>6)</sup>	%	155	155	150	150
		Low-temperature <sup>6)</sup>	%	233	233	222	222
m	Annual energy consumption (Colder)	Medium-temperature <sup>6)</sup>	kWh	6538	6538	7074	7074
		Low-temperature <sup>6)</sup>	kWh	5669	5669	6076	6076
n	Annual energy consumption (Warmer)	Medium-temperature <sup>6)</sup>	kWh	3392	3392	3883	3883
		Low-temperature <sup>6)</sup>	kWh	2978	2978	3380	3380
o	L <sub>WA</sub> (sound power level, outdoor)		dB	64	64	66	66

r <sup>1)</sup> Precautions as described in the installation/user manual must be taken when assembling, installing and maintaining this product.

## PRODUCT FICHE (ENERGY LABELLING OF PACKAGES OF SPACE HEATER) <sup>iii)</sup>

a	Supplier's name or trademark		Samsung Electronics Co., Ltd.	Samsung Electronics Co., Ltd.	Samsung Electronics Co., Ltd.	Samsung Electronics Co., Ltd.
b	Supplier's model identifier		AE090JXEDEH/ AE090JNYDEH	AE090JXEDGH/ AE090JNYDGH	AE120JXEDEH/ AE160JNYDEH	AE120JXEDGH/ AE160JNYDGH
s	Seasonal space heating energy efficiency (Preferential space heater)	%	130	133	114	114
t	Factor for weighting the heat output (Preferential space heater)	-	0	0	0	0
u	Mathematical expression : $294 \sqrt{115 \text{Prated}}$	-	4.5	4.5	3.3	3.3
v	Mathematical expression : $115 \sqrt{115 \text{Prated}}$	-	1.7	1.7	1.3	1.3
w	The difference between the seasonal space heating energy efficiencies under average and colder climate conditions <sup>3)</sup>	%	20	19	5	5
x	The difference between the seasonal space heating energy efficiencies under warmer and average climate conditions <sup>4)</sup>	%	26	1	45	45

a	Supplier's name or trademark		Samsung Electronics Co., Ltd.	Samsung Electronics Co., Ltd.	Samsung Electronics Co., Ltd.	Samsung Electronics Co., Ltd.
b	Supplier's model identifier		AE140JXEDEH/ AE160JNYDEH	AE140JXEDGH/ AE160JNYDGH	AE160JXEDEH/ AE160JNYDEH	AE160JXEDGH/ AE160JNYDGH
s	Seasonal space heating energy efficiency (Preferential space heater)	%	112	112	110	110
t	Factor for weighting the heat output of the preferential and supplementary heaters	-	0	0	0	0
u	Mathematical expression : $294 \sqrt{115 \text{Prated}}$	-	3.0	3.0	2.7	2.7
v	Mathematical expression : $115 \sqrt{115 \text{Prated}}$	-	1.2	1.2	1.0	1.0
w	The difference between the seasonal space heating energy efficiencies under average and colder climate conditions <sup>3)</sup>	%	1	1	5	5
x	The difference between the seasonal space heating energy efficiencies under warmer and average climate conditions <sup>4)</sup>	%	45	45	42	42

y <sup>1)</sup> Whereby Prated is related to the preferential space heater.

z <sup>2)</sup> Whereby Prated is related to the preferential space heater.

aa <sup>3), 4)</sup> For preferential heat pump space heaters.

## PRODUCT FICHE (ENERGY LABELLING OF TEMPERATURE CONTROLS) <sup>iv)</sup>

a	Supplier's name or trademark	-	Samsung Electronics Co., Ltd.	Samsung Electronics Co., Ltd.	Samsung Electronics Co., Ltd.	Samsung Electronics Co., Ltd.
b	Supplier's model identifier	-	AE090JNYDEH	AE090JNYDGH	AE160JNYDEH	AE160JNYDGH
ab	The class of the temperature control	-	Class II	Class II	Class II	Class II
ac	The contribution of the temperature control to seasonal space heating energy efficiency	%	2	2	2	2

# COMMISSION DELEGATED REGULATION (EU) No 811/2013 <sup>i)</sup>

No	English(EN)	Bulgarian(BG)	Spanish(ES)	Czech(CS)
i	COMMISSION DELEGATED REGULATION (EU) No 811/2013	ДЕЛЕГИРАН РЕГЛАМЕНТ (ЕС) № 811/2013 НА КОМИСИЯТА	REGLAMENTO DELEGADO (UE) No 811/2013 DE LA COMISIÓN	NAŘÍZENÍ KOMISE V PŘENESENÉ PRÁVOMOCI (EU) č. 811/2013
ii	PRODUCT FICHE (ENERGY LABELLING OF SPACE HEATERS)	Продуктов фиш (енергийното етикетиране на отоплителни топлоизточници)	Ficha del producto (etiquetado energético de aparatos de calefacción)	Informační list výrobku (energie na energetických štítcích ohřivačů pro vytápění vnitřních prostorů)
iii	PRODUCT FICHE (ENERGY LABELLING OF PACKAGES OF SPACE HEATER)	Продуктов фиш (енергийното етикетиране на КОМПЛЕКТИ ОТ ОТОПИЛТЕЛЕН ТОПЛОИЗТОЧНИК)	Ficha del producto (etiquetado energético de EQUIPOS COMBINADOS DE APARATO DE CALEFACCIÓN)	Informační list výrobku (energie na energetických štítcích ohřivačů pro souprav sestávajících z ohřivače pro vytápění vnitřních prostorů)
iv	PRODUCT FICHE (ENERGY LABELLING OF TEMPERATURE CONTROLS)	Продуктов фиш (енергийното етикетиране на доставчика)	Ficha del producto (etiquetado energético de CONTROLES DE TEMPERATURA)	Informační list výrobku (energie na energetických štítcích ohřivačů pro regulátoru teploty)
a	Supplier's name or trademark	наименование или търговска марка на доставчика	nombre o marca comercial del proveedor	název nebo ochranná známka dodavatele
b	Supplier's model identifier	идентификатор на доставчика за модела	identificador del modelo del proveedor	identifikační značka modelu používaná dodavatelem
c	Seasonal space heating energy efficiency class	класът на сезонна отоплителна енергийна ефективност	la clase de eficiencia energética estacional de calefacción	třída sezonní energetické účinnosti vytápění
d	Rated heat output (Average)	номиналната топлинна мощност (средни)	la potencia calorífica nominal (medias)	jmenovitý tepelný výkon (průměrných)
e	Seasonal space heating energy efficiency (Average)	сезонната енергийна ефективност при отопление (средни)	la eficiencia energética estacional de calefacción (medias)	sezonní energetická účinnost vytápění (průměrných)
f	Annual energy consumption (Average)	годишното потребление на енергия (средни)	el consumo anual de energía (medias)	roční spotřeba energie (průměrných)
g	L <sub>w</sub> (sound power level, indoors)	L <sub>w</sub> (нивото на звуковата мощност, на закрито)	LWA (el nivel de potencia acústica, en interiores)	L <sub>w</sub> (případně hladina akustického výkonu, vnitřním prostorem)
h	Specific precautions <sup>1)</sup>	специфични предпазни <sup>1)</sup>	precauciones específicas <sup>1)</sup>	konkrétní preventivní opatření <sup>1)</sup>
i	Rated heat output (Colder)	номиналната топлинна мощност (по-студени)	la potencia calorífica nominal (l)	jmenovitý tepelný výkon (chladnějších)
j	Rated heat output (Warmer)	номиналната топлинна мощност (по-топли)	la potencia calorífica nominal (l)	jmenovitý tepelný výkon (teplejších)
k	Seasonal space heating energy efficiency (Colder)	сезонната енергийна ефективност при отопление (по-студени)	la eficiencia energética estacional de calefacción (más frías)	sezonní energetická účinnost vytápění (chladnějších)
l	Seasonal space heating energy efficiency (Warmer)	сезонната енергийна ефективност при отопление (по-топли)	la eficiencia energética estacional de calefacción (más cálidas)	sezonní energetická účinnost vytápění (teplejších)
m	Annual energy consumption (Colder)	годишното потребление на енергия (по-студени)	el consumo anual de energía (más frías)	roční spotřeba energie (chladnějších)
n	Annual energy consumption (Warmer)	годишното потребление на енергия (по-топли)	el consumo anual de energía (más cálidas)	roční spotřeba energie (teplejších)
o	L <sub>w</sub> (sound power level, outdoors)	L <sub>w</sub> (нивото на звуковата мощност, на открито)	LWA (el nivel de potencia acústica, en exteriores)	L <sub>w</sub> (případně hladina akustického výkonu, venkovním prostorem)
p	Medium-temperature	среднотемпературни	de temperatura media	středněteplotní
q	Low-temperature	нискотемпературни	de baja temperatura	nizkoteplotní
r	<sup>1)</sup> Precautions as described in the installation/ user manual must be taken when assembling, installing and maintaining this product.	<sup>1)</sup> Описаните в ръководството за монтаж/ ръководството за потребителя предпазни мерки трябва да се спазват при събиране, мониториране и поддръжка на продукта.	<sup>1)</sup> Las precauciones descritas en los manuales de usuario e instalación deben tomarse cuando se ensambla, instala y mantiene este producto	<sup>1)</sup> Při montáži, instalaci a údržbě tohoto produktu je třeba se řídit bezpečnostními opatřeními popsanyými v instalační a uživatelské příručce.
s	Seasonal space heating energy efficiency (Preferential space heater)	сезонната енергийна ефективност при отопление (приоритетно използвания отоплителен топлоизточник)	la eficiencia energética estacional de calefacción (aparato de calefacción preferente)	Seasonal space heating energy efficiency (preferovaného ohřivače pro vytápění vnitřních prostorů)
t	Factor for weighting the heat output of the preferential and supplementary heaters	теговният коефициент за претегляне на топлината енергия, произведена от приоритетно използвания и от допълнителния подревел на даден комплект	el factor de ponderación de la potencia calorífica de los calefactores preferente y complementario de un equipo combinado	factor pro porovnání tepelného výkonu preferovaného ohřivače a přidavných ohřivačů soupravy
u	Mathematical Expression 294(11) Prated	математическо израз 294(11) Prated	la expresión matemática 294(11) Prated	hodnotu matematického výrazu : 294 / (11) Prated
v	Mathematical Expression 150(11) Prated	математическо израз 150(11) Prated	la expresión matemática 150(11) Prated	hodnotu matematického výrazu : 115 / (11) Prated
w	The difference between the seasonal space heating energy efficiencies under average and colder climate conditions <sup>3)</sup>	разликата между сезонната отоплителна енергийна ефективност при средни климатични условия и тази при по-студени климатични условия <sup>3)</sup>	la diferencia entre las eficiencias energéticas estacionales de calefacción en condiciones climáticas medias y más frías, expresado en porcentaje	rozdílů sezonních energetických účinností vytápění za průměrných a chladnějších klimatických podmínek <sup>3)</sup>
x	The difference between the seasonal space heating energy efficiencies under warmer and average climate conditions <sup>4)</sup>	разликата между сезонната отоплителна енергийна ефективност при по-топли климатични условия и тази при средни климатични условия <sup>4)</sup>	la diferencia entre las eficiencias energéticas estacionales de calefacción en condiciones climáticas más cálidas y medias, expresado en porcentaje	rozdílů sezonních energetických účinností vytápění za teplejších a průměrných klimatických podmínek <sup>4)</sup>
y	<sup>1)</sup> Whereby Prated is related to the preferential space heater.	<sup>1)</sup> Където Prated е свързана с приоритетно използвания отоплителен топлоизточник	<sup>1)</sup> donde la Prated está relacionada con el aparato de calefacción preferente	<sup>1)</sup> přičemž Prated se vztahuje k preferovanému ohřivači pro vytápění vnitřních prostorů
z	<sup>2)</sup> Whereby Prated is related to the preferential space heater.	<sup>2)</sup> Където Prated е свързана с приоритетно използвания отоплителен топлоизточник	<sup>2)</sup> donde la Prated está relacionada con el aparato de calefacción preferente	<sup>2)</sup> preferovanému ohřivači pro vytápění vnitřních prostorů
aa	<sup>3)</sup> / <sup>4)</sup> For preferential heat pump space heaters	<sup>3)</sup> / <sup>4)</sup> за приоритетно използвани отоплителни термомпийни агрегати	<sup>3)</sup> / <sup>4)</sup> en lo que respecta a los aparatos de calefacción preferentes con bomba de calor	<sup>3)</sup> / <sup>4)</sup> preferovaných ohřivačů pro vytápění vnitřních prostorů s tepelným čerpadlem navíc
ab	The class of the temperature control	класът на регулатора на температурата	la clase del control de temperatura	třída regulátoru teploty
ac	The contribution of the temperature control to seasonal space heating energy efficiency	приносът на регулатора на температурата към сезонната енергийна ефективност при отопление	la contribución del control de temperatura a la eficiencia energética estacional de calefacción	přínos regulátoru teploty k sezonní energetické účinnosti vytápění

No	Danish(DA)	German(DE)	Estonian(ET)	Greek(EL)
i	KOMMISSIONENS DELEGEREDE FORORDNING (EU) Nr. 811/2013	DELEGIERTE VERORDNUNG (EU) Nr. 811/2013 DER KOMMISSION	KOMISJONI DELEGERITUD MÄÄRUS (EL) nr 811/2013	ΚΑΤ' ΕΞΟΥΣΙΟΔΟΤΗΤΗ ΚΑΝΟΝΙΣΜΟΣ (ΕΕ) αριθ. 811/2013 ΤΗΣ ΕΠΙΤΡΟΠΗΣ
ii	Produktatablad (energimærkning af anlæg til rumopvarmning)	Produktdatenblatt (Energiekennzeichnung von Raumheizgeräten)	Tootekirjeldus (energiamärgistusega kohta kütteseadmest)	Δελτίο προϊόντος (ενεργειακή επισήμανση των θερμαντήρων χώρου)
iii	Produktatablad (energimærkning af anlæg til pakker med anlæg til rumopvarmning)	Produktdatenblatt (Energiekennzeichnung von Verbundanlagen aus Raumheizgeräten)	Tootekirjeldus (energiamärgistusega kohta kütteseadme, komplekt)	Δελτίο προϊόντος (ενεργειακή επισήμανση των των των συσκευασμένων θερμαντήρα χώρου)
iv	Produktatablad (energimærkning af anlæg til temperaturstyring)	Produktdatenblatt (Energiekennzeichnung von Temperaturreglern)	Tootekirjeldus (energiamärgistusega kohta temperatuuriregulaatorist)	Δελτίο προϊόντος (ενεργειακή επισήμανση των ρυθμιστή θερμοκρασίας)
a	leverandørens navn eller varemærke	Name oder Warenzeichen des Lieferanten	tamija nimi või kaubamärk	το όνομα/η επωνυμία του προμηθευτή ή εμπορικό σήμα
b	leverandørens modelidentifikation	Modellkennung des Lieferanten	tamija mudelitähis	το αναγνωριστικό μοντέλου από τον προμηθευτή
c	klasse for årsvirkningsgrad ved rumopvarmning fastslået	die Klasse für die jahreszeitbedingte Raumheizungs-Energieeffizienz	kütmise sesoonse energiatõhususe klass	η τάξη ενεργειακής απόδοσης της εποχιακής θέρμανσης χώρου
d	den nominelle nytteeffekt (gennemsnitlige)	die Wärmenennleistung (durchschnittlichen)	nimisoojusvõimsus (keskmistel)	η ονομαστική θερμική ισχύς (μέσος)
e	årsvirkningsgraden ved rumopvarmning (gennemsnitlige)	die jahreszeitbedingte Raumheizungs-Energieeffizienz (durchschnittlichen)	kütmise sesoonse energiatõhusus (keskmistel)	η ενεργειακή απόδοση της εποχιακής θέρμανσης χώρου σε (μέσος)
f	det årlige energiforbrug (gennemsnitlige)	den jährlichen Energieverbrauch (durchschnittlichen)	aastane energiatarimine (keskmistel)	ετήσια κατανάλωση ενέργειας (μέσος)
g	LWA (lydeffektniveauet, inde)	LWA (den Schalleistungspegel, in Innenräumen)	LWA (müravõimsustase, siseruumis)	LWA (η στάθμη ηχητικής ισχύος, εσωτερικού χώρου)
h	specifikke forholdsregler <sup>1)</sup>	besonderen Vorkehrungen <sup>1)</sup>	ettevaatusmeetmed kütteseadme koostamisel <sup>1)</sup>	ειδικές προφυλάξεις <sup>1)</sup>
i	den nominelle nytteeffekt (koldere)	die Wärmenennleistung (kälteren)	nimisoojusvõimsus (külmema)	η ονομαστική θερμική ισχύς (ψυχρότερες)
j	den nominelle nytteeffekt (varmere)	die Wärmenennleistung (wärmeren)	nimisoojusvõimsus (soojema)	η ονομαστική θερμική ισχύς (θερμότερες)
k	årsvirkningsgraden ved rumopvarmning (koldere)	die jahreszeitbedingte Raumheizungs-Energieeffizienz (kälteren)	kütmise sesoonse energiatõhusus (külmema)	η ενεργειακή απόδοση της εποχιακής θέρμανσης χώρου σε (ψυχρότερες)
l	årsvirkningsgraden ved rumopvarmning (varmere)	die jahreszeitbedingte Raumheizungs-Energieeffizienz (wärmeren)	kütmise sesoonse energiatõhusus (soojema)	η ενεργειακή απόδοση της εποχιακής θέρμανσης χώρου σε (θερμότερες)
m	det årlige energiforbrug (koldere)	den jährlichen Energieverbrauch (kälteren)	aastane energiatarimine (külmema)	ετήσια κατανάλωση ενέργειας (ψυχρότερες)
n	det årlige energiforbrug (varmere)	den jährlichen Energieverbrauch (wärmeren)	aastane energiatarimine (soojema)	ετήσια κατανάλωση ενέργειας (θερμότερες)
o	L <sub>WA</sub> (lydeffektniveauet, ude)	L <sub>WA</sub> (den Schalleistungspegel, im Freien)	L <sub>WA</sub> (müravõimsustase, väljas)	L <sub>WA</sub> (η στάθμη ηχητικής ισχύος, εξωτερικού χώρου)
p	middeitemperatur	Mitteltemperatur	keskmisel temperatuuril	μέσος θερμοκρασίας
q	lavtemperatur	Niedertemperatur	külma kliima	χαμηλή θερμοκρασίας
r	<sup>1)</sup> Du skal tage de forholdsregler, der er beskrevet i installations-/brugervejledningen, når du samler, installerer og vedligeholder dette produkt.	<sup>1)</sup> Beim Montieren, Installieren und Warten des Geräts müssen die im Installations-/ Benutzerhandbuch beschriebenen Vorsichtsmaßnahmen eingehalten werden.	<sup>1)</sup> Toote kokkupanekul, installimisel ja hooldamisel järgige paigaldus-/kasutusjuhend kirjeldatud ettevaatusabinõusid.	<sup>1)</sup> Όταν συναρμολογείτε, εγκαθιστάτε και συντηρείτε αυτό το προϊόν, πρέπει να λαμβάνετε τις προφυλάξεις που περιγράφονται στο εγχειρίδιο εγκατάστασης/χρήσης.
s	årsvirkningsgraden ved rumopvarmning (det primære anlæg til rumopvarmning)	Seasonal space heating energy efficiency (Vorzugsraumheizgerätes)	kütmise sesoonse energiatõhusus (põhikütteseadme)	η ενεργειακή απόδοση της εποχιακής θέρμανσης χώρου σε (προτιμώμενου θερμαντήρα χώρου)
t	faktoren for vægtning af den nominelle nytteeffekt af primære og supplerende forsyningsanlæg i en pakke	Faktor zur Gewichtung der Wärmeleistung der Vorzugs- und Zusatzheizgeräte	komplekti põhi- ja täiendavate kütteseadmete soojusvõimsuse kaalumistegur vastavalt käesoleva	ο συντελεστής στάθμης της θερμικής ισχύος του προτιμώμενου και του συμπληρωματικού θερμαντήρα του συσκευασμένου
u	værdien af det matematiske udtryk: $\frac{294}{11(1+Prated)}$	Wert des mathematischen Ausdrucks: $\frac{294}{11(1+Prated)}$	$\frac{matemaatilise avaldise 294}{11(1+Prated)}$	$\frac{\eta \mu\alpha\theta\eta\mu\alpha\tau\iota\kappa\eta\ \alpha\upsilon\lambda\alpha\delta\iota\sigma\eta\ 294}{11(1+Prated)}$
v	værdien af det matematiske udtryk: $\frac{152}{11(1+Prated)}$	Wert des mathematischen Ausdrucks: $\frac{152}{11(1+Prated)}$	$\frac{matemaatilise avaldise 152}{11(1+Prated)}$	$\frac{\eta \mu\alpha\theta\eta\mu\alpha\tau\iota\kappa\eta\ \alpha\upsilon\lambda\alpha\delta\iota\sigma\eta\ 152}{11(1+Prated)}$
w	værdien af forskellen mellem årsvirkningsgraden ved rumopvarmning under gennemsnitlige og koldere klimaforhold <sup>3)</sup>	Wert der Differenz zwischen der jahreszeitbedingten Raumheizungs-Energieeffizienz bei durchschnittlichen und derjenigen bei kälteren Klimaverhältnissen <sup>3)</sup>	keskmistel kliimatingimustel ja külmema kliima korral leitud kütmise sesoonsete energiatõhususte vahe <sup>3)</sup>	διαφοράς της ενεργειακής απόδοσης της εποχιακής θέρμανσης χώρου υπό μέσος και ψυχρότερες κλιματικές συνθήκες <sup>3)</sup>
x	værdien af forskellen mellem årsvirkningsgraden ved rumopvarmning under varmere og gennemsnitlige klimaforhold <sup>4)</sup>	Wert der Differenz zwischen der jahreszeitbedingten Raumheizungs-Energieeffizienz bei wärmeren und derjenigen bei durchschnittlichen Klimaverhältnissen <sup>4)</sup>	soojema kliima korral ja keskmistel kliimatingimustel leitud kütmise sesoonsete energiatõhususte vahe <sup>4)</sup>	διαφοράς της ενεργειακής απόδοσης της εποχιακής θέρμανσης χώρου υπό θερμότερες και μέσος κλιματικές συνθήκες <sup>4)</sup>
y	<sup>1)</sup> hvor Prated vedrører det primære anlæg til rumopvarmning	<sup>1)</sup> wobei sich Prated auf das Vorzugsraumheizgerät bezieht	<sup>1)</sup> siin Prated iseloomustab põhikütteseadet	<sup>1)</sup> όπου Prated αφορά τον προτιμώμενο θερμαντήρα χώρου
z	<sup>2)</sup> hvor Prated vedrører det primære anlæg til rumopvarmning	<sup>2)</sup> wobei sich Prated auf das Vorzugsraumheizgerät bezieht	<sup>2)</sup> siin Prated iseloomustab põhikütteseadet	<sup>2)</sup> όπου Prated αφορά τον προτιμώμενο θερμαντήρα χώρου
aa	<sup>3)</sup> , <sup>4)</sup> for primære varmepemppeanlæg til rumopvarmning	<sup>3)</sup> , <sup>4)</sup> für Vorzugsraumheizgeräte mit Wärmepumpe	<sup>3)</sup> , <sup>4)</sup> soojuspumbaga põhikütteseadmete kohta	<sup>3)</sup> , <sup>4)</sup> για τους προτιμώμενους θερμαντήρες χώρου με αντλία θερμότητας
ab	klasse for temperaturstyring	die Klasse des Temperaturreglers	temperatuuriregulaatori klass	η τάξη του ρυθμιστή θερμοκρασίας
ac	temperaturstyringens andel af årsvirkningsgraden ved rumopvarmning i procent afrundet til en decimal	Beitrag des Temperaturreglers zur jahreszeitbedingten Raumheizungs-Energieeffizienz	temperatuuriregulaatori osa kütmise sesoonse energiatõhususes	το μερίδιο του ρυθμιστή θερμοκρασίας στην ενεργειακή απόδοση της εποχιακής θέρμανσης χώρου

# COMMISSION DELEGATED REGULATION (EU) No 811/2013 <sup>i)</sup>

No	French(FR)	Croatian(HR)	Italian(IT)	Latvian(LV)
i	RÈGLEMENT DÉLÉGUÉ (UE) No 811/2013 DE LA COMMISSION	DELEGIRANA UREDBA KOMISIJE (EU) br. 811/2013	REGOLAMENTO DELEGATO N. 811/2013 DELLA COMMISSIONE EUROPEA	KOMISIJAS DELEĢĀTĀJREGULA (ES) Nr. 811/2013
ii	Fiche de produit (l'étiquetage énergétique des dispositifs de chauffage des locaux)	Informacijski list proizvoda (označivanja energetske učinkovitosti grijača prostora)	Scheda prodotto (l'etichetta indica il consumo d'energia degli apparati per il riscaldamento)	Ražojuma datu lapa (energomarķējumu uz telpu sildītāju)
iii	Fiche de produit (l'étiquetage énergétique des produit combiné constitué d'un dispositif de chauffage des locaux)	Informacijski list proizvoda (označivanja energetske učinkovitosti kompleta koji sadržavaju grijač prostora)	Scheda prodotto (l'etichetta indica il consumo d'energia degli insiemi di apparati per il riscaldamento)	Ražojuma datu lapa (energomarķējumu uz telpu sildītāja iekārtas, komplektu)
iv	Fiche de produit (l'étiquetage énergétique des d'un régulateur de température)	Informacijski list proizvoda (označivanja energetske učinkovitosti uređaj za upravljanje temperaturom)	Scheda prodotto (l'etichetta indica il consumo d'energia dispositivi di controllo della temperatura)	Ražojuma datu lapa (energomarķējumu uz temperatūras regulatori)
a	le nom du fournisseur ou la marque commerciale	naziv ili zaštitni znak dobavljača	il nome o marchio del fornitore	piegādātāja nosaukums vai preču zīme
b	la référence du modèle donnée par le fournisseur	dobavljačeva identifikācijas oznaka modela	Identificativo del modello del fornitore	piegādātāja modeļa identifikators
c	la classe d'efficacité énergétique saisonnière, pour le chauffage des locaux	razred sezone energetske učinkovitosti pri zagrijavanju prostora	la classe di efficienza energetica stagionale di riscaldamento	telpu apsildes sezonas energoefektivitātes klase
d	la puissance thermique nominale (moyennes)	navazna toplinska snaga (prosjecnim)	la potenza termica nominale (medie)	nomiņai siltuma jauda (vidējais)
e	l'efficacité énergétique saisonnière pour le chauffage des locaux (moyennes)	sezonska energetska učinkovitost pri zagrijavanju prostora (prosjecnim)	l'efficienza energetica stagionale di riscaldamento (dell'ambiente (medie))	telpu apsildes sezonas energoefektivitāte (vidējais)
f	la consommation annuelle d'énergie (moyennes)	godišnja potrošnja energije (prosjecnim)	il consumo annuo di energia (medie)	gada enerģijas patēriņš (vidējais)
g	L <sub>w</sub> (le niveau de puissance acoustique, à l'intérieur)	L <sub>w</sub> (razina zvučne snage, u zatvorenom)	LWA (il livello di potenza sonora, interna)	L <sub>w</sub> (akustiskās jaudas līmenis, telpās)
h	les précautions particulières <sup>1)</sup>	posebne mjere opreza <sup>1)</sup>	eventuali precauzioni <sup>1)</sup>	īpaši piesardzības pasākumi <sup>1)</sup>
i	la puissance thermique nominale (plus froides)	navazna toplinska snaga (hladnijim)	la potenza termica nominale (più fredde)	nomiņai siltuma jauda (aukstākos)
j	la puissance thermique nominale (plus chaudes)	navazna toplinska snaga (toplijim)	la potenza termica nominale (più calde)	nomiņai siltuma jauda (siltākos)
k	l'efficacité énergétique saisonnière pour le chauffage des locaux (plus froides)	sezonska energetska učinkovitost pri zagrijavanju prostora (hladnijim)	l'efficienza energetica stagionale di riscaldamento (più fredde)	telpu apsildes sezonas energoefektivitāte (aukstākos)
l	l'efficacité énergétique saisonnière pour le chauffage des locaux (plus chaudes)	sezonska energetska učinkovitost pri zagrijavanju prostora (toplijim)	l'efficienza energetica stagionale di riscaldamento (più calde)	telpu apsildes sezonas energoefektivitāte (siltākos)
m	la consommation annuelle d'énergie (plus froides)	godišnja potrošnja energije (hladnijim)	il consumo annuo di energia (più fredde)	gada enerģijas patēriņš (aukstākos)
n	la consommation annuelle d'énergie (plus chaudes)	godišnja potrošnja energije (toplijim)	il consumo annuo di energia (più calde)	gada enerģijas patēriņš (siltākos)
o	L <sub>w</sub> (le niveau de puissance acoustique, à l'extérieur)	L <sub>w</sub> (razina zvučne snage, na otvorenom)	LWA (il livello di potenza sonora, all'esterno)	L <sub>w</sub> (akustiskās jaudas līmenis, ārpus telpām)
p	moyenne température	srednjin temperatūrama	media temperatura	vidējais temperatūras
q	basse température	nisko temperatūrama	bassa temperatura	Zemas temperatūras
r	<sup>1)</sup> Des précautions, comme décrit dans le manuel d'installation/d'utilisation, doivent être prises lors du montage, de l'installation et de l'entretien de l'appareil.	<sup>1)</sup> Prilikom sastavljanju, instalacije i održavanja proizvoda potrebno je poduzeti mjere opreza navedene u priručniku za instalaciju / korisničkom priručniku.	<sup>1)</sup> Le precauzioni descritte nel manuale Installazione/Utente devono essere rispettate in fase di montaggio, installazione e manutenzione del prodotto	<sup>1)</sup> Izstrādājuma salikšanas, uzstādīšanas un apkopes laikā jāievēro uzstādīšanas/lietošanas rokasgrāmatā norādītie piesardzības pasākumi.
s	l'efficacité énergétique saisonnière pour le chauffage des locaux (du dispositif de chauffage des locaux utilisé à titre principal)	sezonska energetska učinkovitost pri zagrijavanju prostora (primarnog grijača prostora)	l'efficienza energetica stagionale di riscaldamento (preferenziale per il riscaldamento)	telpu apsildes sezonas energoefektivitāte (preferenciāli telpu sildītāja)
t	le coefficient de pondération de la puissance thermique du dispositif de chauffage utilisé à titre principal et du dispositif de chauffage d'appoint d'un produit combiné	težinski faktor toplinske snage primarnog ili dodatnih grijača u kompletu	il fattore di ponderazione della potenza termica degli apparecchi di riscaldamento preferenziali o supplementari di un insieme	koeficients komplekta preferenciāli n papildu sildītāja siltuma jaudas svērtās vērtības iegūšanai
u	l'expression mathématique $1,25 \times (1 + \frac{1}{n})$	matematiķskais formula $1,25 \times (1 + \frac{1}{n})$	espressione matematica $1,25 \times (1 + \frac{1}{n})$	matemātiskās izteiksmes $1,25 \times (1 + \frac{1}{n})$
v	l'expression mathématique $1,15 \times (1 + \frac{1}{n})$	matematiķskais formula $1,15 \times (1 + \frac{1}{n})$	espressione matematica $1,15 \times (1 + \frac{1}{n})$	matemātiskās izteiksmes $1,15 \times (1 + \frac{1}{n})$
w	la différence entre les efficacités énergétiques saisonnières pour le chauffage des locaux dans les conditions climatiques moyennes et plus froides <sup>3)</sup>	razlike između sezonskih energetske učinkovitosti pri zagrijavanju prostora u prosječnim i hladnijim klimatskim uvjetima <sup>3)</sup>	Differenza tra l'efficienza energetica stagionale di riscaldamento in condizioni climatiche medie e più fredde <sup>3)</sup>	atšķirība starp telpu apsildes sezonas energoefektivitāti vidējos un aukstākos apstākļos <sup>3)</sup>
x	la différence entre les efficacités énergétiques saisonnières pour le chauffage des locaux dans les conditions climatiques plus chaudes et moyennes <sup>4)</sup>	razlike između sezonskih energetske učinkovitosti pri zagrijavanju prostora u toplijim i prosječnim klimatskim uvjetima <sup>4)</sup>	Differenza tra l'efficienza energetica stagionale di riscaldamento in condizioni climatiche più calde e medie <sup>4)</sup>	atšķirība starp telpu apsildes sezonas energoefektivitāti siltākos un vidējos apstākļos <sup>4)</sup>
y	<sup>1)</sup> dans laquelle Prated renvoie au dispositif de chauffage des locaux utilisé à titre principal	<sup>1)</sup> pri čemu se Prated odnosi na primarni grijač prostora	<sup>1)</sup> dove Prated si riferisce all'apparecchio per il riscaldamento preferenziale	<sup>1)</sup> vērtība, kur Prated attiecas uz preferenciālo telpu sildītāju
z	<sup>2)</sup> dans laquelle Prated renvoie au dispositif de chauffage des locaux utilisé à titre principal	<sup>2)</sup> pri čemu se Prated odnosi na primarni grijač prostora	<sup>2)</sup> dove Prated si riferisce all'apparecchio per il riscaldamento preferenziale	<sup>2)</sup> vērtība, kur Prated attiecas uz preferenciālo telpu sildītāju
aa	<sup>3), 4)</sup> pour les dispositifs de chauffage des locaux par pompe à chaleur utilisés à titre principal	<sup>3), 4)</sup> za primarne toplinske crpkje za grijanje prostora	<sup>3), 4)</sup> per gli apparati per il riscaldamento preferenziali a pompa di calore	<sup>3), 4)</sup> preferenciālijam siltumsūkņa telpu sildītājiem
ab	la classe du régulateur de température	razred uređaja za upravljanje temperaturom	la classe del dispositivo di controllo della temperatura	temperatūras regulatora klase
ac	la contribution du régulateur de température à l'efficacité énergétique saisonnière pour le chauffage des locaux	doprinis uređaja za upravljanje temperaturom sezonskoj energetske učinkovitosti pri zagrijavanju prostora	il contributo del dispositivo di controllo della temperatura all'efficienza energetica stagionale di riscaldamento	temperatūras regulatora devums telpu apsildes sezonas energoefektivitāte

No	Lithuanian(LT)	Hungarian(HU)	Maltese(MT)	Dutch(NL)
i	KOMISIJOS DELEGUOTASIS REGLAMENTAS (ES) Nr. 811/2013	A BIZOTTSÁG 811/2013/EU FELHATALMAZÁSON ALAPULÓ RENDELETE	REGOLAMENT TA DELEGA TAL-KUMMISSJONI (UE) Nru 811/2013	GEDELEGEERDE VERORDENING (EU) Nr. 811/2013 VAN DE COMMISSIE
ii	Gaminio vardinų parametų lentelė (energijos vartojimo efektyvumo ženklinimo dėd patalpų šildytuvu)	Termékismertető adatlap (energiafogyasztásának címkézése a helyiségfűtő berendezések)	L-iskeda tat-tagħrif tal-prodott (tikkettar enerġetiku ta' hiters tal-post)	Productkaart (de energie-etikettering van ruimteverwarmingstoelsten)
iii	Gaminio vardinų parametų lentelė (energijos vartojimo efektyvumo ženklinimo dėd patalpų šildytuvu, komplektu)	Termékismertető adatlap (energiafogyasztásának címkézése a helyiségfűtő berendezésből)	L-iskeda tat-tagħrif tal-prodott (tikkettar enerġetiku ta' paketti magħlum minn hiters tal-post)	Productkaart (de energie-etikettering van pakketten van ruimteverwarmingstoelsten)
iv	Gaminio vardinų parametų lentelė (energijos vartojimo efektyvumo ženklinimo dėd temperatūros regulatoriaus)	Termékismertető adatlap (energiafogyasztásának címkézése a hőmérséklet-szabályozóból)	L-iskeda tat-tagħrif tal-prodott (tikkettar enerġetiku ta' regulator tat-temperatura)	Productkaart (de energie-etikettering van temperatuurregelaars)
a	kiekėjo pavadinimas arba prekės ženklas	a beszállító neve vagy védjegye	isem il-fornitur jew il-marka kummerġjali tiegħu	de naam van de leverancier of het handelsmerk
b	kiekėjo modelio žymuo	a beszállító által megadott modellazonosító	Identifikator tal-mudell tal-fornitur	de typeaanduiding van de leverancier
c	sezoninio energijos patalpoms šildyti vartojimo efektyvumo klasė	szézonális helyiségfűtési energiahatékonysági osztálya	il-klasi tal-effiġjenza enerġetika staġonali tat-tishin tal-post	de seizoensgebonden energie-efficiëntieklasse voor ruimteverwarming
d	vardinis šilumos atidavimas (vidutinio)	a mért hőteljesítmény (átlagos)	il-potenza termika nominali (medji)	de nominale warmteafgifte (gemiddelde)
e	sezoninis energijos patalpoms šildyti vartojimo efektyvumas (vidutinio)	a szezonális helyiségfűtési hatásfok (átlagos)	l-effiġjenza enerġetika staġonali tat-tishin tal-post (medji)	de seizoensgebonden energie-efficiëntie voor ruimteverwarming (gemiddelde)
f	metinis energijos suvartojimas (vidutinio)	az éves energiafogyasztás (átlagos)	il-konsum annwali tal-enerġija (medji)	het jaarlijkse energiegebruik (gemiddelde)
g	L <sub>wk</sub> (garso galios lygis, patalpoje decibelais)	L <sub>wk</sub> (hangteljesítményszint, beltéri)	L <sub>wk</sub> (il-livell ta' qawwa tal-Poss, fuq għerwa)	L <sub>wk</sub> (het geluidsvernogensniveau, binnen)
h	specialios atsarugumo priemonės <sup>31</sup>	külön övintézkedések <sup>31</sup>	prekawzjonijet specifika <sup>31</sup>	specifieke voorzorgmaatregelen <sup>31</sup>
i	vardinis šilumos atidavimas (šaltiesnio)	a mért hőteljesítmény (hidegebb)	il-potenza termika nominali (iksaħ)	de nominale warmteafgifte (koudere)
j	vardinis šilumos atidavimas (šiltiesnio)	a mért hőteljesítmény (melegebb)	il-potenza termika nominali (išan)	de nominale warmteafgifte (warmere)
k	sezoninis energijos patalpoms šildyti vartojimo efektyvumas (šaltiesnio)	a szezonális helyiségfűtési hatásfok (hidegebb)	l-effiġjenza enerġetika staġonali tat-tishin tal-post (iksaħ)	de seizoensgebonden energie-efficiëntie voor ruimteverwarming (koudere)
l	sezoninis energijos patalpoms šildyti vartojimo efektyvumas (šiltiesnio)	a szezonális helyiségfűtési hatásfok (melegebb)	l-effiġjenza enerġetika staġonali tat-tishin tal-post (išan)	de seizoensgebonden energie-efficiëntie voor ruimteverwarming (warmere)
m	metinis energijos suvartojimas (šaltiesnio)	az éves energiafogyasztás (hidegebb)	il-konsum annwali tal-enerġija (iksaħ)	het jaarlijkse energiegebruik (koudere)
n	metinis energijos suvartojimas (šiltiesnio)	az éves energiafogyasztás (melegebb)	il-konsum annwali tal-enerġija (išan)	het jaarlijkse energiegebruik (warmere)
o	L <sub>wk</sub> (garso galios lygis, lauke decibelais)	L <sub>wk</sub> (hangteljesítményszint, kültéri)	L <sub>wk</sub> (il-livell ta' qawwa tal-Poss, fuq barra)	L <sub>wk</sub> (het geluidsvernogensniveau, buiten)
p	vidutinėje temperatūroje	közepes hőmérsékletű	b'temperatura medja	midden temperatuur
q	žematemperatūris	alacsony hőmérsékletű	b'temperatura baxxa	lagtemperatuur
r	<sup>31</sup> Montuojant ar įrengiant šį produktą, taip pat atliekant jo techninę priežiūrą, būtina atsižvelgti į montavimo / naudojimo vadovė aprašytas atsargumo priemones.	<sup>31</sup> A termék összeszerelése, telepítése és a karbantartása során tartása be a telepítési/használati útmutatóban leírt óvintézkedéseket.	<sup>31</sup> Prekawzjonijiet kif deskritt fl-installazzjoni u l-utent manwali għandhom jittiehdha meta jlaqqa l-installazzjoni, u Żżamma dan il-prodott	<sup>31</sup> De voorzorgmaatregelen die in de gebruikershandleiding worden beschreven, moeten in acht worden genomen bij montage, installatie en onderhoud van dit product.
s	sezoninis energijos patalpoms šildyti vartojimo efektyvumas (pirmiausia naudojamo patalpų šildytuvu)	a szezonális helyiségfűtési hatásfok (az elsődleges helyiségfűtő berendezés)	l-effiġjenza enerġetika staġonali tat-tishin tal-post (tat-tishin tal-post tal-hiters tal-post preferenzjali)	de seizoensgebonden energie-efficiëntie voor ruimteverwarming (ruimteverwarming van de hoofdverwarming)
t	komplekto pirmiausia naudojami ir papildomo šildytuvų šilumos atidavimo svoris koeficientas	a csomagban található elsődleges és kiegészítő fűtőberendezések hőteljesítményének súlyozására szolgáló tényező	il-fattur għall-ippažar tal-potenza termika tal-hiters preferenzjali u tal-hiters supplementari ta' pakett	de factor voor het wegen van de warmteafgifte van hoofd- en aanvullende verwarmingstoelsten van een pakket
u	matematini koeficientas $\frac{1}{15} \left( \frac{Prated}{P} \right)$	matematikai tényező $\frac{1}{15} \left( \frac{Prated}{P} \right)$	ta-formola matematika $\frac{1}{15} \left( \frac{Prated}{P} \right)$	de koefiġjenz għall-formula $\frac{1}{15} \left( \frac{Prated}{P} \right)$
v	matematini koeficientas $\frac{1}{15} \left( \frac{Prated}{P} \right)$	matematikai tényező $\frac{1}{15} \left( \frac{Prated}{P} \right)$	ta-formola matematika $\frac{1}{15} \left( \frac{Prated}{P} \right)$	de koefiġjenz għall-formula $\frac{1}{15} \left( \frac{Prated}{P} \right)$
w	sezoninių energijos patalpoms šildyti vartojimo efektyvumų skirtumo vidutinio ir šaltiesnio klimato sąlygomis <sup>32</sup>	az átlagos és a hidegebb éghajlati viszonyok mellett mért szezonális helyiségfűtési hatásfok közötti különbség <sup>32</sup>	tad-differenza bejn l-effiġjenza enerġetika staġonali tat-tishin tal-post f'kundizzjonijiet klimatiki medji u dik f'kundizzjonijiet klimatiki iksaħ <sup>32</sup>	het verschil tussen de seizoensgebonden energie-efficiënties voor ruimteverwarming onder warmere en gemiddelde klimaatomstandigheden <sup>32</sup>
x	sezoninių energijos patalpoms šildyti vartojimo efektyvumų skirtumo šiltiesnio ir vidutinio klimato sąlygomis <sup>33</sup>	a melegebb és az átlagos éghajlati viszonyok mellett mért szezonális helyiségfűtési hatásfok közötti különbség <sup>33</sup>	tad-differenza bejn l-effiġjenza enerġetika staġonali tat-tishin tal-post f'kundizzjonijiet klimatiki medji u dik f'kundizzjonijiet klimatiki išan <sup>33</sup>	het verschil tussen de seizoensgebonden energie-efficiënties voor ruimteverwarming onder gemiddelde en koudere klimaatomstandigheden <sup>33</sup>
y	<sup>31</sup> kur Prated yra susijęs su pirmiausia naudojamu patalpų šildytuvu	<sup>31</sup> ahol a Prated az elsődleges helyiségfűtő berendezésre vonatkozik	<sup>31</sup> fejn il-valur ta' Prated huwa marbut mal-hiters tal-post preferenzjali	<sup>31</sup> waarbij Prated is gerelateerd aan het ruimteverwarmingstoelst als hoofdverwarming
z	<sup>32</sup> kur Prated yra susijęs su pirmiausia naudojamu patalpų šildytuvu	<sup>32</sup> ahol a Prated az elsődleges helyiségfűtő berendezésre vonatkozik	<sup>32</sup> fejn il-valur ta' Prated huwa marbut mal-hiters tal-post preferenzjali	<sup>32</sup> waarbij Prated is gerelateerd aan het ruimteverwarmingstoelst als hoofdverwarming
aa	<sup>33</sup> , <sup>34</sup> pirmiausia naudojamų patalpų šildytuvų su šilumos siurbliu	<sup>33</sup> , <sup>34</sup> elsődleges hőszivattyús helyiségfűtő berendezések esetében	<sup>33</sup> , <sup>34</sup> għall-hiters tal-post preferenzjali b'pompa ta-shana	<sup>33</sup> , <sup>34</sup> voor ruimteverwarmingstoelsten met warmtepomp als hoofdverwarming
ab	temperatūros regulatoriaus klasė	a hőmérséklet-szabályozó osztálya	il-klasi tar-regulator tat-temperatura	de klasse van de temperatuurregelaar
ac	temperatūros regulatoriaus sandas sezoniniam energijos patalpoms šildyti vartojimo efektyvumui	a hőmérséklet-szabályozó szezonális helyiségfűtési hatásfokhoz való hozzájárulásának	il-kontribut tar-regulator tat-temperatura għall-effiġjenza enerġetika staġonali tat-tishin tal-post	de bijdrage van de temperatuurregelaar aan de seizoensgebonden energie-efficiëntie voor ruimteverwarming

# COMMISSION DELEGATED REGULATION (EU) No 811/2013 <sup>1)</sup>

No	Polish(PL)	Portuguese(PT)	Romanian(RO)	Slovak(SK)
i	ROZPORZĄDZENIE DELEGOWANE KOMISJI (UE) NR 811/2013	REGULAMENTO DELEGADO (UE) Nº 811/2013 DA COMISSÃO	REGULAMENTUL DELEGAT AL COMISIEI (UE) NR. 811/2013	DELEGOVANÉ NARIADENIE KOMISIE (EÚ) č. 811/2013
ii	Karta produktu (w odniesieniu do etykiet efektywności energetycznej dla ogrzewaczy pomieszczeń)	Ficha de produto (rotulagem energética dos aquecedores de ambiente)	Fișă produsului (ce privește clasa de energie a instalațiilor pentru încălzirea încălțitorilor)	Informačný list (energetické označovanie tepelných zdrojov na vykurovanie priestoru)
iii	Karta produktu (w odniesieniu do etykiet efektywności energetycznej dla zestawów zawierających ogrzewacz pomieszczeń)	Ficha de produto (rotulagem energética dos sistemas mistos de aquecedor de ambiente)	Fișă produsului (ce privește clasa de energie a instalațiilor pentru încălzirea încălțitorilor)	Informačný list (energetické označovanie tepelných zdrojov na vykurovanie priestoru)
iv	Karta produktu (w odniesieniu do etykiet efektywności energetycznej dla regulatorów temperatury)	Ficha de produto (rotulagem energética dos dispositivos de controlo de temperatura)	Fișă produsului (ce privește etichetarea energetică a regulatorilor de temperatură)	Informačný list (energetické označovanie regulatorov teploty)
a	nazwa dostawcy lub jego znak towarowy	Nome do fornecedor	Denumirea sau marca comercială a furnizorului	meno dodávateľa alebo ochranná známka
b	identyfikator modelu dostawy	Modelo	Modelul identificador al furnizorului	identifikačný kód modelu
c	klasa sezonowej efektywności energetycznej ogrzewania pomieszczeń	Clase de eficiência energética do aquecimento ambiente sazonal	Clasa de eficiență energetică sezonieră aferentă încălzirii încălțitorilor	trieda sezónnej energetickej účinnosti vykurovania priestoru
d	Znamionowa moc cieplna (uśredniona)	Potência calorífica nominal (condições climáticas médias)	Puterea termică nominală (medie)	menovitý tepelný výkon (priemerný)
e	Sezonowa efektywność energetyczna ogrzewania pomieszczeń (uśredniona)	Eficiência energética do aquecimento ambiente sazonal (condições climáticas médias)	Eficiență energetică sezonieră aferentă încălzirii încălțitorilor (medie)	sezónna energetická účinnosť vykurovania priestoru (priemerná)
f	Roczne zużycie energii (uśrednione)	Consumo anual de energia (condições climáticas médias)	Consumul anual de energie (medie)	ročná spotreba energie (priemerná)
g	LWA (poziom mocy akustycznej, w pomieszczeniu)	LWA (Nível de potência sonora, no interior)	LWA (nívelul de putere acustică, la interior)	LWA (hladina akustického výkonu, vnútroštné jednotky)
h	Szczegółne środki ostrożności <sup>1)</sup>	Precauções específicas <sup>1)</sup>	Măsură de precauție specifică <sup>2)</sup>	osobitné bezpečnostné opatrenie <sup>1)</sup>
i	znamionowa moc cieplna (chłodnego)	Potência calorífica nominal (condições climáticas mais frias)	Puterea termică nominală (mai reci)	menovitý tepelný výkon (chladnejší)
j	znamionowa moc cieplna (cieplego)	Potência calorífica nominal (condições climáticas mais quentes)	Puterea termică nominală (mai calde)	menovitý tepelný výkon (teplejší)
k	sezonowa efektywność energetyczna ogrzewania pomieszczeń (chłodnego)	Eficiência energética do aquecimento ambiente sazonal (condições climáticas mais frias)	Eficiență energetică sezonieră aferentă încălzirii încălțitorilor (mai reci)	sezónna energetická účinnosť vykurovania priestoru (chladnejší)
l	sezonowa efektywność energetyczna ogrzewania pomieszczeń (cieplego)	Eficiência energética do aquecimento ambiente sazonal (condições climáticas mais quentes)	Eficiență energetică sezonieră aferentă încălzirii încălțitorilor (mai calde)	sezónna energetická účinnosť vykurovania priestoru (teplejší)
m	roczne zużycie energii (chłodnego)	Consumo anual de energia (condições climáticas mais frias)	Consum anual de energie (mai reci)	ročná spotreba energie (chladnejší)
n	roczne zużycie energii (cieplego)	Consumo anual de energia (condições climáticas mais quentes)	Consum anual de energie (mai calde)	ročná spotreba energie (teplejších)
o	LWA (poziom mocy akustycznej, na zewnątrz)	LWA (Nível de potência sonora, no exterior)	LWA (nívelul de putere acustică, la exterior)	LWA (hladina akustického výkonu, vonkajšie jednotky)
p	średniotemperaturowe	média temperatura	Temperatură medie	středná teplota
q	niskotemperaturowe	baixa temperatura	Temperatură scăzută	nizkotéplotné
r	<sup>1)</sup> Podczas montażu, instalacji oraz serwisowaniu produktu należy stosować szczególne środki ostrożności zgodnie z informacjami zawartymi w instrukcji instalacji podlegzniku użytkownika.	<sup>1)</sup> As precauções descritas no manual de instalação/instruções dever ser adotadas durante a montagem, instalação ou manutenção do produto.	<sup>1)</sup> Atenționări, descrie în manualul de instalare/operate, ce trebuie luate în considerare când se asamblează, instalează sau întreține acest produs.	<sup>1)</sup> Bezpečnostné opatrenia, ktoré sú popísané v instalačnej/používateľskej príručke, sa musia vykonať pri inštalácii a údržbe tohto produktu.
s	sezonowa efektywność energetyczna ogrzewania pomieszczeń (podstawowego ogrzewacza pomieszczeń)	Eficiência energética do aquecimento ambiente sazonal (do aquecedor de ambiente preferencial)	Eficiență energetică sezonieră aferentă încălzirii încălțitorilor (al instalației preferențiale pentru încălzirea încălțitorilor)	sezónna energetická účinnosť vykurovania priestoru (uprednostňovaného tepelného zdroja na vykurovanie priestoru)
t	współczynnik ważący moc cieplną ogrzewaczy podstawowych oraz ogrzewaczy dodatkowych w zestawie	o fator de ponderação da potência calorífica do aquecedor preferencial e dos aquecedores complementares de um sistema misto	factorul de pondere a puterii termice a instalațiilor de încălzire preferențiale și suplimentare din cadrul unui pachet	súčiniteľ na váznenie tepelného výkonu uprednostňovaného tepelného zdroja a dodatkových tepelných zdrojov
u	Wartość wyrażenia matematycznego: $29 \frac{40}{11} \frac{1}{100} \frac{1}{100} \frac{1}{100}$	Expressão matemática: $29 \frac{40}{11} \frac{1}{100} \frac{1}{100} \frac{1}{100}$	Valoarea expresiei matematice: $29 \frac{40}{11} \frac{1}{100} \frac{1}{100} \frac{1}{100}$ nominal	matematický výraz: $29 \frac{40}{11} \frac{1}{100} \frac{1}{100} \frac{1}{100}$
v	Wartość wyrażenia matematycznego: $11 \frac{5}{11} \frac{1}{100} \frac{1}{100} \frac{1}{100}$	Expressão matemática: $11 \frac{5}{11} \frac{1}{100} \frac{1}{100} \frac{1}{100}$	Valoarea expresiei matematice: $11 \frac{5}{11} \frac{1}{100} \frac{1}{100} \frac{1}{100}$ nominal	matematický výraz: $11 \frac{5}{11} \frac{1}{100} \frac{1}{100} \frac{1}{100}$
w	Różnica między sezonowymi efektywnościami energetycznymi ogrzewania pomieszczeń w warunkach klimatu umiarkowanego i chłodnego <sup>3)</sup>	Diferença entre as eficiências energéticas do aquecimento ambiente sazonal em condições climáticas médias e em condições climáticas mais frias <sup>3)</sup>	Diferența dintre eficiența energetică sezonieră aferentă încălzirii încălțitorilor în condiții climatice medii și mai reci <sup>3)</sup>	hodnota rozdielu sezónnych energetických účinností vykurovania priestoru za priemerných a chladnejších podmienok <sup>3)</sup>
x	Różnica między sezonowymi efektywnościami energetycznymi ogrzewania pomieszczeń w warunkach klimatu ciepłego i umiarkowanego <sup>4)</sup>	Diferença entre as eficiências energéticas do aquecimento ambiente sazonal em condições climáticas mais quentes e em condições climáticas médias <sup>4)</sup>	Diferența dintre eficiența energetică sezonieră aferentă încălzirii încălțitorilor în condiții climatice calde și medii <sup>4)</sup>	hodnota rozdielu sezónnych energetických účinností vykurovania priestoru za teplejších a priemerných podmienok <sup>4)</sup>
y	<sup>1)</sup> gdzie Prated dotyczy podstawowego ogrzewacza pomieszczeń	<sup>1)</sup> em que Prated diz respeito ao aquecedor de ambiente preferencial	<sup>1)</sup> Unde Pr nominal se referă la instalația preferențială pentru încălzirea încălțitorilor.	<sup>1)</sup> kde Prated súvisí s uprednostňovaným tepelným zdrojom na vykurovanie priestoru
z	<sup>2)</sup> gdzie Prated dotyczy podstawowego ogrzewacza pomieszczeń	<sup>2)</sup> em que Prated diz respeito ao aquecedor de ambiente preferencial	<sup>2)</sup> Unde Pr nominal se referă la instalația preferențială pentru încălzirea încălțitorilor.	<sup>2)</sup> kde Prated súvisí s uprednostňovaným tepelným zdrojom na vykurovanie priestoru
aa	<sup>3)</sup> <sup>4)</sup> Dla podstawowych ogrzewaczy pomieszczeń z pompą ciepła	<sup>3)</sup> <sup>4)</sup> para os aquecedores de ambiente preferenciais com bomba de calor	<sup>3)</sup> <sup>4)</sup> Pentru instalațiile preferențiale cu pompă de căldură pentru încălzirea încălțitorilor.	<sup>3)</sup> <sup>4)</sup> pre uprednostňované tepelné zdroje na vykurovanie priestoru – tepelné čerpadlá
ab	klasa regulatora temperatury	A classe do dispositivo de controlo de temperatura	Clasa regulatorului de temperatură	trieda regulatora teploty
ac	udział regulatora temperatury w sezonowej efektywności energetycznej ogrzewania pomieszczeń	A contribuição do dispositivo de controlo de temperatura para a eficiência energética do aquecimento ambiente sazonal	Contribuția regulatorului de temperatură la eficiența energetică sezonieră aferentă încălzirii încălțitorilor	príspevok regulatora teploty k sezónnej energetickej účinnosti vykurovania priestoru



No	Slovenian(SL)	Finnish(FI)	Swedish(SV)
i	DELEGIJANA UREDBA KOMISIJE (EU) št. 811/2013	KOMMISSION DELEGOITU ASETUS (EU) N:o 811/2013	KOMMISSIONENS DELEGERADE FÖRORDNING (EU) nr 811/2013
ii	Podatkovni list izdelka (energijskega označevanja grelnikov prostorov)	Tuoteseloste (tilälämmittimien, energiamerkinnän)	Produktblad (energimärkning av pannor och värmepumpar för rumsuppvärmning)
iii	Podatkovni list izdelka (energijskega označevanja kompletov grelnika prostorov)	Tuoteseloste (tilälämmittimestä, energiamerkinnän)	Produktblad (energimärkning av paket med pannor och värmepumpar för rumsuppvärmning)
iv	Podatkovni list izdelka (energijskega označevanja naprave za uravnavanje temperature)	Tuoteseloste (lämmönsäätölaitteesta, energiamerkinnän)	Produktblad (energimärkning av temperaturregulator)
a	dobavitelj/ve ime ali blagovna znamka	tavarantoimittajan nimi tai tavaramerkki	Leverantörens namn eller varumärke
b	dobaviteljeva identifikacijska oznaka modela	tavarantoimittajan mallitunniste	Leverantörens modellbeteckning
c	razred sezonske energijske učinkovitosti pri ogrevanju prostorov	tilälämmityksen kausittainen energiatehokkuusluokka	säsongsrelaterade energieffektivitetsklass vid rumsuppvärmning
d	nazivna izhodna toplota (popvprečnih)	niemiläslämpöteho, mukaan lukien mahdollisen lisälämmittimen niemiläslämpöteho (keskimääräisissä)	Den nominella avgivna värmeeffekten (genomsnittliga)
e	sezonska energijska učinkovitost pri ogrevanju prostorov (popvprečnih)	tilälämmityksen kausittainen energiatehokkuus (keskimääräisissä)	Säsongsmedelverkningsgrad för rumsuppvärmning (genomsnittliga)
f	letna poraba energije (popvprečnih)	vuotuinen energiankulutus (keskimääräisissä)	Årlig energiförbrukning (genomsnittliga)
g	L <sub>W</sub> (raven zvočne moči, notranja)	L <sub>W</sub> (äänitehotas, sisällä disibeleinä)	L <sub>W</sub> (Ljudeffektivit, inomhus)
h	posebni varnostni ukrepi <sup>1)</sup>	erityiset varotoimenpiteet <sup>1)</sup>	särskilda försiktighetsåtgärder <sup>1)</sup>
i	nazivna izhodna toplota (hladnejših)	niemiläslämpöteho, mukaan lukien mahdollisen lisälämmittimen niemiläslämpöteho (kylmissä)	Den nominella avgivna värmeeffekten (kallare)
j	nazivna izhodna toplota (toplejših)	niemiläslämpöteho, mukaan lukien mahdollisen lisälämmittimen niemiläslämpöteho (lämpimissä)	Den nominella avgivna värmeeffekten (varmare)
k	sezonska energijska učinkovitost pri ogrevanju prostorov (hladnejših)	tilälämmityksen kausittainen energiatehokkuus (kylmissä)	Säsongsmedelverkningsgrad för rumsuppvärmning (kallare)
l	sezonska energijska učinkovitost pri ogrevanju prostorov (toplejših)	tilälämmityksen kausittainen energiatehokkuus (lämpimissä)	Säsongsmedelverkningsgrad för rumsuppvärmning (varmare)
m	letna poraba energije (hladnejših)	vuotuinen energiankulutus (kylmissä)	Årlig energiförbrukning (kallare)
n	letna poraba energije (toplejših)	vuotuinen energiankulutus (lämpimissä)	Årlig energiförbrukning (varmare)
o	L <sub>W</sub> (raven zvočne moči, zunanja)	L <sub>W</sub> (äänitehotas, ulkona disibeleinä)	L <sub>W</sub> (Ljudeffektivit, utomhus)
p	srednjih temperaturah	keskilämpötilan	mediumtemperatur
q	nizkoteperatura	matalan lämpötilan	lågtemperatur
r	<sup>1)</sup> Pri sestavljanju, namešanju ter vzdrževanju izdelka upoštevajte previdnostne ukrepe, ki so navedeni v priročniku za uporabo in namestitve.	<sup>1)</sup> Asennus- tai käyttöoppaassa kuvattuja turvaohjeita on noudatettava laitteen kokoamisen, asentamisen ja huollon aikana.	<sup>1)</sup> Försiktighetsåtgärder som beskrivs i installationsmanualen/bruksanvisningen måste följas vid montering, installation och underhåll av denna produkt.
s	sezonska energijska učinkovitost pri ogrevanju prostorov (za prednostni grelnik prostorov)	tilälämmityksen kausittainen energiatehokkuus (ensisijaisen tilälämmittimen tilälämmityksen)	Säsongsmedelverkningsgrad för rumsuppvärmning (primära pannans eller värmepumpens)
t	ensisijaisen lämmittimen ja lisälämmittimen lämpötehon painotuskertoin	ensisijaisen lämmittimen ja lisälämmittimen lämpötehon painotuskertoin	Viktningfaktor för primär- och tillsatsvärmarens värmeproduktion för paket
u	matemaattinen arvo $\frac{1}{15} \left( \frac{1}{11} \text{Prated} \right)^2$	matemaattinen arvo $\frac{1}{15} \left( \frac{1}{11} \text{Prated} \right)^2$	matematisk värde $\frac{1}{15} \left( \frac{1}{11} \text{Prated} \right)^2$
v	matemaattinen arvo $\frac{1}{15} \left( \frac{1}{11} \text{Prated} \right)^2$	matemaattinen arvo $\frac{1}{15} \left( \frac{1}{11} \text{Prated} \right)^2$	matematisk värde $\frac{1}{15} \left( \frac{1}{11} \text{Prated} \right)^2$
w	razlike med sezonskima energijskima učinkovitostma pri ogrevanju prostorov v popvprečnih in hladnejših podnebnih razmerah <sup>3)</sup>	keskimääräisissä ja kylmissä ilmasto-olosuhteissa saavutettavien tilälämmityksen kausittaisen energiatehokkuuksien ero <sup>3)</sup>	Skillnaden mellan den säsongsrelaterade energieffektiviteten vid rumsuppvärmning under genomsnittliga och kallare klimatförhållanden <sup>3)</sup>
x	razlike med sezonskima energijskima učinkovitostma pri ogrevanju prostorov v toplejših in popvprečnih podnebnih razmerah <sup>4)</sup>	lämpimissä ja keskimääräisissä ilmasto-olosuhteissa saavutettavien tilälämmityksen kausittaisen energiatehokkuuksien ero <sup>4)</sup>	Skillnaden mellan den säsongsrelaterade energieffektiviteten vid rumsuppvärmning under varmare och genomsnittliga klimatförhållanden <sup>4)</sup>
y	<sup>1)</sup> pri čemer se Prated navezuje na prednostni grelnik prostorov	<sup>1)</sup> jossa Prated liittyy ensisijaiseen tilälämmittimeen	<sup>1)</sup> där Prated är relaterat till den primära pannan eller värmepumpen
z	<sup>2)</sup> pri čemer se Prated navezuje na prednostni grelnik prostorov	<sup>2)</sup> jossa Prated liittyy ensisijaiseen tilälämmittimeen	<sup>2)</sup> där Prated är relaterat till den primära pannan eller värmepumpen
aa	<sup>3)</sup> , <sup>4)</sup> prednostne toplotne črpalke za ogrevanje prostorov	<sup>3)</sup> , <sup>4)</sup> ensisijaisista lämpöpumputilälämmittimistä	<sup>3)</sup> , <sup>4)</sup> för primära värmare med värmepump för rumsuppvärmning
ab	razred naprave za uravnavanje temperature	lämmönsäätölaitteen luokka	Temperaturregulatorns klass
ac	prispevek naprave za uravnavanje temperature k sezonski energijski učinkovitosti pri ogrevanju prostorov	lämmönsäätölaitteen vaikutus tilälämmityksen kausittaisen energiatehokkuuteen	Temperaturregulatorns bidrag till säsongsmedelverkningsgraden för rumsuppvärmning

# **SAMSUNG**

SAMSUNG ELECTRONICS CO., LTD.

107, Hanamsandan 6beon-ro, Gwangsan-gu, Gwangju-si, Korea 62218

Samsung Electronics (UK) Ltd, Euro QA Lab.

Blackbushe Business Park. Saxony Way, Yateley, Hampshire. GU46 6GG United Kingdom